



Partner in the process industry

Components and solutions
for your success

PHOENIX CONTACT – in dialog with customers and partners worldwide

Phoenix Contact is a global market leader in the field of electrical engineering, electronics, and automation. Founded in 1923, the family-owned company now employs around 14,000 people worldwide. A sales network with over 50 sales subsidiaries and more than 30 additional global sales partners guarantees customer proximity directly on site, anywhere in the world.

Our range of services consists of all kinds of products with a wide range of electrotechnical applications. This includes numerous connection technologies for device manufacturers and machine building, components for modern control cabinets, and tailor-made solutions for many applications and industries, such as the automotive industry, wind energy, solar energy, the process industry or applications in the field of water supply, power transmission and distribution, and transportation infrastructure.



Global player with personal customer contact

Company independence is an integral part of our corporate policy. Phoenix Contact therefore relies on in-house competence and expertise in a range of contexts: the design and development departments constantly come up with innovative product ideas, developing special solutions to meet customer requirements. Numerous patents emphasize the fact that many of Phoenix Contact's products have been developed in-house.





Phoenix Contact - partner in the process industry

Pages 2–5

Trends in the process industry

Pages 6–13

Overview - from the field to the control system

Pages 14–15

Products and solutions for the process industry

- Network components
- Power supplies
- Connection technology and marking
- Signal connection (Ex, non-Ex, relays, SIL, etc.)
- Device circuit breakers and surge protection
- Energy and motor management
- System cabling
- Digital fieldbus (FF, PROFIBUS PA, HART)
- Remote control solutions - communication infrastructure

Pages 16–141

Services and support

- Terminal boxes (empty and equipped)
- Configuration software

Pages 142–155

Basic principles of the process industry

Pages 156–189

We connect the field to the control room

Phoenix Contact offers comprehensive, innovative solutions for process technology and process engineering. In addition to conventional point-to-point connections and the latest fieldbus and Ethernet communication, modern wireless networks can also be created. Phoenix Contact supplies products and solutions for a wide range of applications, from the field to the control room.

Thanks to our marked expertise in this field, as well as in energy supply, device manufacturing, machine building, and systems manufacturing, in addition to standard solutions we are particularly adept at producing future-oriented crossover solutions for process technology and process engineering.

The special requirements for process technology are met and this is documented by comprehensive global approval packages. Easy-to-understand training and technology seminars covering all process engineering applications and solutions complete our range of services.

Your advantages at a glance

- Concept supplier and solution provider for the entire system (one-stop shopping)
- Large range of components with extensive manufacturing capability
- Global standards and technologies
- Training and training program, service, and support



Our range of services for you

- Terminal blocks with screw, spring-cage, IDC, and push-in technology
- System cabling and marshalling modules for all leading process control systems
- Relays, optocouplers, and solid-state contactors, including for safety applications
- Signal converters and signal isolators up to SIL 3
- Power supplies, redundancy modules, and UPS solutions
- Surge and EMC protective elements for digital and analog field signals up to Ex i
- Fieldbus infrastructure for FOUNDATION Fieldbus, PROFIBUS DP, and PROFIBUS PA
- Components for wired and WirelessHART communication
- Solutions for industrial modem and wireless communication, as well as for secure remote maintenance
- Infrastructure components for Ethernet, PROFINET, and EtherNet/IP™
- Ready-for-assembly junction boxes and marshalling cabinets
- Marking solutions for practically all applications in the system



Standardization of products and solutions (point-to-point)

Operators of large process systems are constantly presented with new challenges that must be met in addition to ensuring system availability. In order to respond quickly and flexibly to the individual needs of their customers, various system concepts are popular solutions.

With our comprehensive technical and industry-specific expertise and the reliable components and future-oriented solutions that we offer, we are here to help you deal with these demands.

Distributed systems

In the process industry and process engineering, systems are required that are tailored exactly to the customer's needs. They should be configurable for future use, mobile, and also support on-site installation. Container modules used in the fine chemicals industry are just one example of these distributed systems.

Modular systems

In addition to distributed systems, as in machine building, the trend towards modular design continues to grow, beginning above all in chemical and pharmaceutical systems. It is now even possible to lease entire system parts. This not only has the advantage of reducing configuration costs considerably (especially for global projects), but also reduces the time spent on system revamps, migrations or system expansions significantly.

Miniaturization

Above all in European process systems, the trend towards miniaturization continues. The main reason for this is the increasing lack of space in control cabinets caused by ever-growing signal density (increased system availability).



System cabling

Wiring I/O modules with single wires is an extremely time-consuming process and wiring errors cannot be ruled out. With VARIOFACE system cabling, it is possible to connect numerous I/O modules from renowned DCS and safety system manufacturers in a quick, space-saving, modular, and error-free way.



Signal conditioning and Ex isolation

Intrinsically safe signal conditioners in the MACX Analog Ex series provide a comprehensive range of functions in a width of just 12.5 mm. The highly compact signal conditioners in the MINI Analog series with an overall width of 6.2 mm save space in the control cabinet for non-intrinsically safe signals. SIL3-certified safety relays for the process industry are adapted to the relevant process control systems. Whether emergency shutdown (ESD) or fire and gas (F&G) applications, every safety signal is sent with certainty thanks to the SIL-certified coupling modules.



Marshalling and distribution

Marshalling panels and marshalling patchboards with push-in connection technology offer maximum signal density and save space by up to 20%. Available in various colors and with various numbers of channels, the highly flexible PTRV and PTMC series can be adapted to the specific marshalling requirements, ensuring a clean structure for the signal wiring.



Stainless steel Ex terminal boxes and empty housings

The CLIPSAFE housing range consists of standardized housings in sizes up to 1000 x 1000 x 300 mm. We can also machine these to your specifications, with consideration given to normative Ex standards according to ATEX and IECEx. They are supplied ready equipped with components and cable glands with corresponding device approval.



System identification

Permanent, robust, and clear marking in the field is crucial for system operators in process technology and process engineering. The TOPMARK LASER marking system is the ideal solution for implementing the requirements of challenging industrial identification. Over 400 markers made of stainless steel, aluminum, ABS, polyacrylics, and polycarbonate are available.



Standardization of processes and communication (bus)

Process communication in large process systems is becoming ever more complex. In order to meet customer requirements and make process sequences more clear and more transparent, various options are available. We have helped shape the following trends and offer components and solutions that enable us to support you when facing these particular challenges.

Linking to modern communication media

Due to the complexity of modern-day systems, it is often no longer possible for end customers to carry out maintenance and diagnostics. As a result, maintenance and system upgrades can only be performed by suppliers. In order to make this process more customer friendly, there is a growing need to find systems that are clearer and easier to use. Apps & Co. or Windows-based systems offer new opportunities here.

Asset management (predictive maintenance)

Unplanned system downtimes result in high costs and can be life-threatening. The early detection of errors and critical system states is therefore crucial in the process industry. In order to increase system availability and keep maintenance costs as low as possible, there is a growing trend towards permanent diagnostics for system control. In the event of an error message, maintenance can then be performed quickly and reliably.

Industrial security

Pipelines or distributed systems sometimes have to be controlled, diagnosed, and maintained remotely over long distances. The security of the signals provided must be ensured in order to avoid failures, for example, due to sabotage. Industrial security is therefore a trend topic.



PROFIBUS DP/PA interface

The modular PROFIBUS interface enables transparent communication between PROFIBUS PA field devices and a higher-level PROFIBUS DP fieldbus and can be extended to ten segments. The web server in the head station supports configuration via DTM and remote diagnostics for the network and all connected field devices.



IT security

With the security products in the mGuard range, you can reliably protect your systems against unauthorized access by people or malware. All incoming and outgoing data packets are monitored using predefined rules. Furthermore, sensitive data can be transmitted to remote system parts in encrypted form over public networks using VPN-capable devices.



WirelessHART

Solutions for applications with WirelessHART. The functions of conventional analog field devices which are connected to non-HART-capable process control systems can be extended easily and without needing to replace the existing control hardware by using WirelessHART networks. On field devices that are already hardwired, WirelessHART adapters can be used to connect to a WirelessHART or WLAN gateway. A wide range of parameterization and diagnostic functions can therefore be integrated into the existing system without having to stop the process.



Field barrier box

The modular fieldbus components in the FB... product range enable communication from the process controller to the field devices for FOUNDATION Fieldbus or PROFIBUS PA applications. The electrically isolated fieldbus power supplies provide power while enabling communication with one segment. The device couplers in the pre-assembled field junction boxes connect the devices and ensure that segments are protected. Combined with redundant DC power supplies and surge protection, a complete connection architecture is provided.



Energy efficiency

Climate protection programs and increasing environmental requirements imposed by countries also affect the process industry. In future, system revamps and expansions will have to observe these requirements and laws. Recycling and energy efficiency are also becoming an increasingly important area of focus for system operators. They play an important role, particularly for large system operators. The aim is to analyze which systems use the most energy, to monitor these systems constantly, and to minimize usage through new technologies such as heat use, waste heat recovery or alternative energies. The use of the right form of energy at the right time and the comparison of energy costs with planned figures is key. At Phoenix Contact, we have helped shape these requirements and trends and offer components and solutions that enable us to support you as a partner when facing these particular challenges.

Energy data acquisition

Use network-capable EMpro meters to monitor characteristic electrical data centrally and on site. The devices are integrated into network structures and fieldbus systems by means of plug-in communication modules. This means that measured values can even be made available in the control center for further processing.



Motor management

Solutions for efficient motor control and monitoring
Three-phase pumps or actuators can be monitored and controlled via a central controller. Communication is established either via gateways or a small-scale controller, which transmits the sensor data using an I/O module.



Power distribution

The screw and push-in connection terminal blocks up to 240 mm² are characterized in particular by their space-saving design and gas-tight, maintenance-free contacts. Both connection technologies are available as single terminal blocks or as 3 to 5-pos. terminal block bases and are tested and approved in accordance with Ex e (EN 60079-07).



Redundancy concepts

The QUINT POWER product range offers functionality at the highest level. Power supplies, DC/DC converters, and redundancy modules are available with a wide range of technologies. For example, in order to trip circuit breakers reliably, SFB technology supplies several times the nominal current for a short period.



System protection and signal quality

The consistent use of TRABTECH surge protection modules for all input and output signals optimally protects your process control system against damage caused by surge voltages. For example, the FLT isolating spark gap prevents damage to sensitive insulating flanges in pipelines caused by a lightning strike.



Training

A lack of personnel or poorly trained personnel often leads to failures in process engineering systems. In order to guarantee system availability, system operators are increasingly focusing on education and training for their staff. In addition to explosion protection and functional safety, the proper handling of products, technologies, and systems, including in the event of an error, is taught. In addition to face-to-face presentations, virtual training is also available online, via Webex or on simulators. At Phoenix Contact, we have helped shape this trend and offer training covering all aspects of standards and technologies, as well as products and solutions that enable us to support you when facing these particular challenges.



Ex protection and intrinsic safety

Explosion protection is an important topic for a growing number of systems. However, the requirements of the Ex directive present a real challenge for many operators and users. Our seminar on the basics, which is aimed at beginners, provides you with the necessary knowledge required for explosion protection and intrinsic safety.

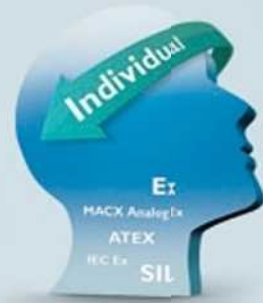

Functional safety

Do you require specialist knowledge about a specific topic in the field of functional safety? And do you want to set the place and time for the seminar? Then contact us for more information. We are, of course, happy to offer advanced seminars on machine safety and the safety lifecycle on an individual basis.



Secure remote maintenance via the Internet

The practical workshop provides an easy introduction to remote maintenance via the Internet. In our full-day workshop, you will get a detailed overview of the basic principles with the aid of practical examples and exercises. Step by step you work on the basic functions of an item of safety equipment and find out about secure remote maintenance using VPN connections. A connection is established between a service technician and a remote station as an example. This connection is established via the UMTS mobile communication network and the Internet. We use mobile communication and mGuard VPN routers in practical exercises. Afterwards, you will receive the configuration files that were developed during the workshop and you can use these files and adapt them to your environment.



Additional seminars

Benefit from our knowledge – from the basic principles to specialist know-how. We will give you the skills you need in a variety of additional seminars.



From the field to the control system – always the right connection

In line with our principle that “We connect the field to your control system”, Phoenix Contact offers a comprehensive range of solutions covering all aspects of automation in process technology and process engineering.

Special solutions tailored to the needs of our customers and our forward-looking product portfolio make us a partner that you can depend on, wherever you are in the world.

Everything for control cabinet installation, such as cable ducts, accessories and tools, and marking can be found in the “Connection technology and marking” section from page 46.

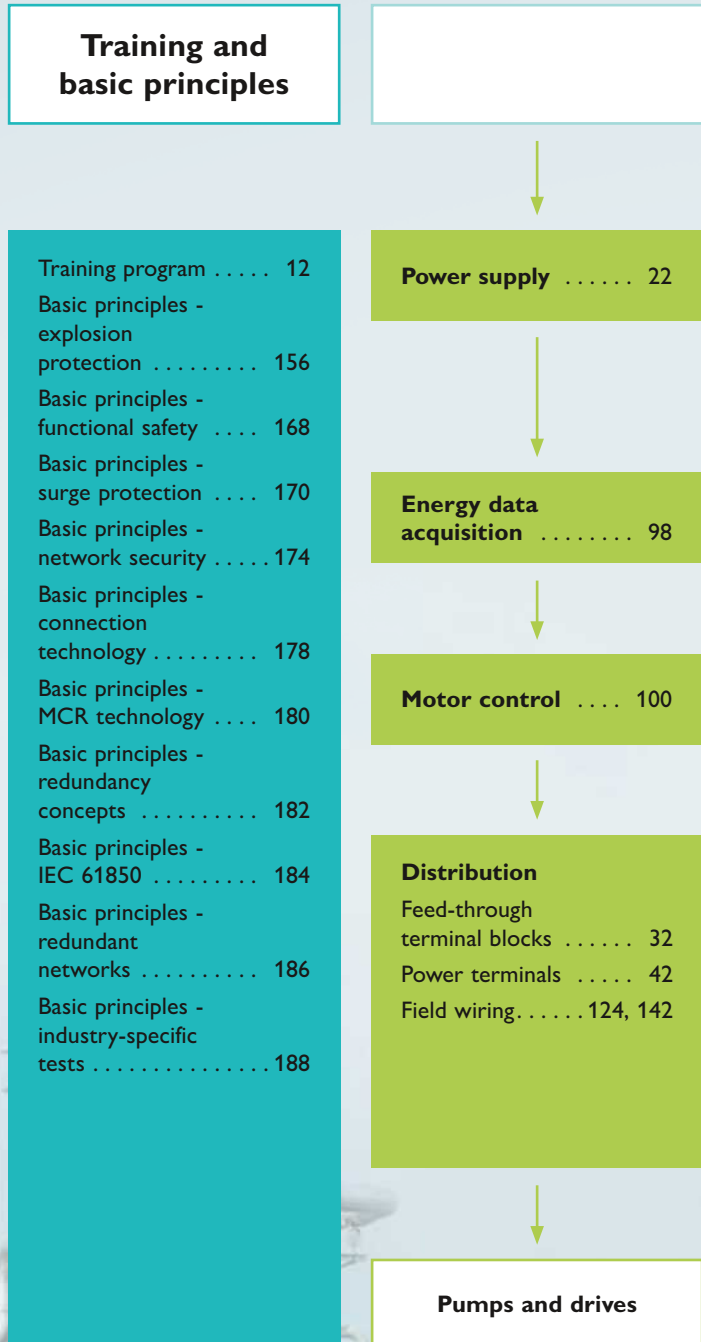



Internet/Intranet infrastructure and security

Process control system

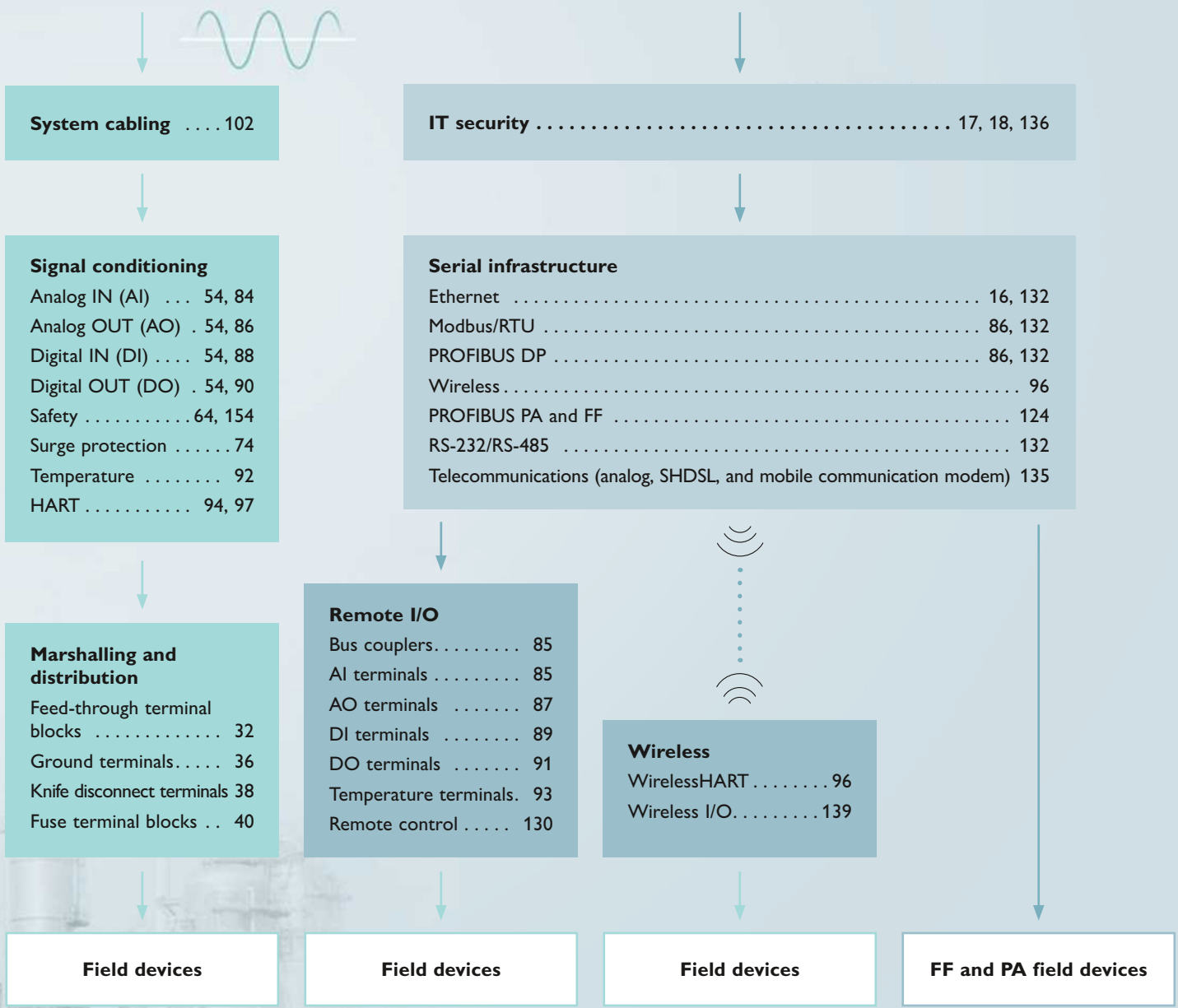

System cabling 102

IT security 17, 18, 136

Signal conditioning

- Analog IN (AI) . . . 54, 84
- Analog OUT (AO) . 54, 86
- Digital IN (DI) 54, 88
- Digital OUT (DO) . 54, 90
- Safety 64, 154
- Surge protection 74
- Temperature 92
- HART 94, 97

Serial infrastructure

- Ethernet 16, 132
- Modbus/RTU 86, 132
- PROFIBUS DP 86, 132
- Wireless 96
- PROFIBUS PA and FF 124
- RS-232/RS-485 132
- Telecommunications (analog, SHDSL, and mobile communication modem) 135

Marshalling and distribution

- Feed-through terminal blocks 32
- Ground terminals 36
- Knife disconnect terminals 38
- Fuse terminal blocks . . 40

Remote I/O

- Bus couplers 85
- AI terminals 85
- AO terminals 87
- DI terminals 89
- DO terminals 91
- Temperature terminals. 93
- Remote control 130

Wireless

- WirelessHART 96
- Wireless I/O 139

Field devices

Field devices

Field devices

FF and PA field devices

Industrial Ethernet

Consistent communication increases productivity

In order to be able to make well-founded decisions, you need all the relevant information at your fingertips. This necessitates a company-wide uniform communication system, from the Production Department to the Company Management. Furthermore, it has never been more important to ensure that you have adequate protection against unauthorized access by people or malware across the entire network. Phoenix Contact provides an infrastructure suitable for industrial applications and with the required approvals for the stringent requirements of the process industry. In addition to the TCP/IP protocol, PROFINET, Fieldbus FF HSE, and EtherNet/IP™ are also used as industrial communication protocols today.

Suitable for industrial applications

Our hardware and software components combine the network functions of the IT world with the special requirements of industrial automation. They are characterized by the following features:

- Easy, automation-typical handling
- Support of various topologies and transmission media
- Optimum time response with high data throughput
- Comprehensive diagnostic features
- High immunity to mechanical strain, electromagnetic interference, vibration, and shock
- Extended temperature range



Industrial Ethernet – network components

High-performance automation switches

High-availability and powerful process networks require a well-structured, high-performance, and robust network infrastructure.

Phoenix Contact offers a wide range of high-performance Managed Switches, which combine IT functions with fast redundancy and realtime properties, thus ensuring the reliable operation of your systems.



Reliable Industrial Wireless solutions

The WLAN access points from Phoenix Contact ensure reliable communication even under harsh conditions and are optimized for fast and stable PROFINET and EtherNet/IP™ transmission. The central cluster management makes configuration and maintenance easier, especially for larger WLAN networks.



Networks secured through modern firewalls

Security products in the mGuard range protect your systems against unauthorized access by people or malware. All incoming and outgoing data packets are monitored using predefined rules. The VPN-capable devices also enable sensitive data to be transmitted to remote system parts in encrypted form over public networks.



Effective surge protection

DATATRAB provides maximum protection against surge voltages at maximum transmission speeds. The versions are system-compliant and are equipped with the appropriate connection technology.



Accessories

In addition to pre-assembled cabling systems, the comprehensive range of Ethernet accessories includes tools, software, and patch fields in various different versions.



Solution concept for Ethernet communication networks

For optimum system security, the individual areas of Internet, office, process control, and remote applications are divided and are clearly separate from one another with regard to their security mechanisms.

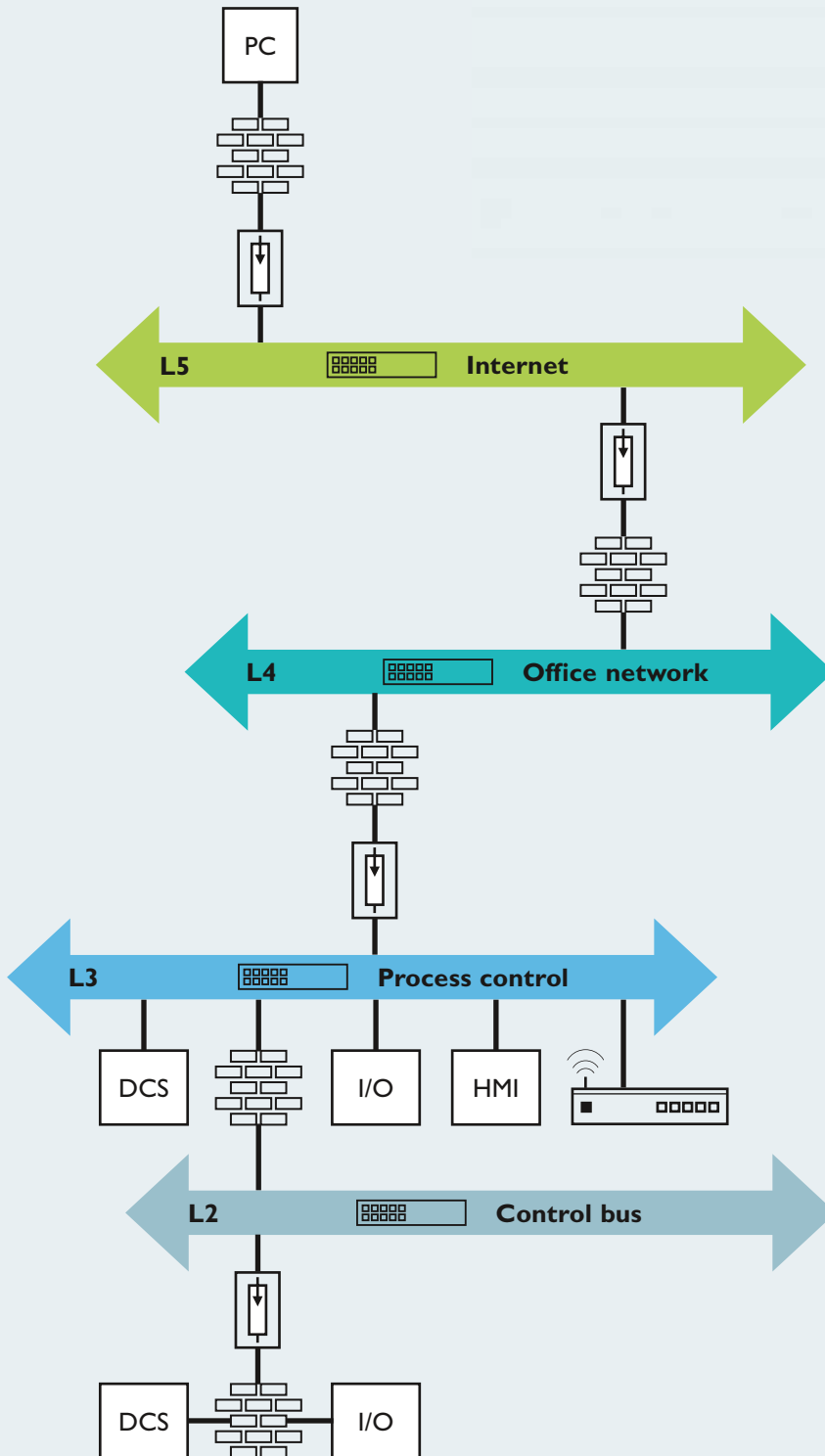

Managed Switches in 19" format

FL SWITCH 4824E4GC

Order No. [2891072](#)

FL SWITCH 4808E-16FX LC-4GC

Order No. [2891073](#)

FL SWITCH 4808E-16FX SM LC-4GC

Order No. [2891074](#)

FL SWITCH 4808E-16FX-4GC

Order No. [2891079](#)

FL SWITCH 4808E-16FX SM-4GC

Order No. [2891080](#)

FL SWITCH 4808E-16FX SM ST-4GC

Order No. [2891086](#)

FL SWITCH 4808E-16FX ST-4GC

Order No. [2891085](#)

Description

IEC 61850 places special requirements on network components. Depending on the installation location, extremely high environmental requirements must be met which are specified in IEC 61850-3. Managed Switches are suitable for use under the harshest conditions, such as in energy systems.



Modular Managed Switches

- FL SWITCH GHS 12G/8**
Order No. [2989200](#)
- FL SWITCH GHS 4G/12**
Order No. [2700271](#)
- FL SWITCH GHS 12G/8-L3**
Order No. [2700787](#)
- FL SWITCH GHS 4G/12-L3**
Order No. [2700786](#)

Smart Managed Switches

- FL SWITCH SMCS 8GT**
Order No. [2891123](#)
- FL SWITCH SMCS 6GT/2SFP**
Order No. [2891479](#)
- FL SWITCH SMCS 6TX/2SFP**
Order No. [2989323](#)
- FL SWITCH SMCS 8TX**
Order No. [2989226](#)
- FL SWITCH SMCS 8TX PN**
Order No. [2989103](#)
- FL SWITCH SMCS 4TX PN**
Order No. [2989093](#)

Advanced Managed Switches

- FL SWITCH 7008-EIP**
Order No. [2701418](#)
- FL SWITCH 7006/2FX-EIP**
Order No. [2701419](#)
- FL SWITCH 7005/FX-2FX SM-EIP**
Order No. [2701420](#)

Security routers

- FL MGuard GT/GT**
Order No. [2700197](#)
- FL MGuard GT/GT VPN**
Order No. [2700198](#)
- FL MGuard RS2000 TX/TX VPN**
Order No. [2700642](#)
- FL MGuard RS4000 TX/TX**
Order No. [2700634](#)
- FL MGuard RS4000 TX/TX VPN**
Order No. [220515](#)
- FL MGuard RS2005 TX VPN**
Order No. [2701875](#)
- FL MGuard RS4004 TX/DTX**
Order No. [2701876](#)
- FL MGuard RS4000 TX/TX-P**
Order No. [2702259](#)

The Modular Managed Switches offer maximum performance with up to 12 Gigabit ports. They can be extended to 28 ports using plug-in termination boards. All FO and copper interfaces used as standard in industrial applications are supported. Managed functions ensure convenient configuration and diagnostic options. The switches are generally used in the process control sector.

The Smart Managed Switches are ideal for applications in which a block switch is required. They are available with copper and FO connection and have a transmission speed of up to 1 Gbps on all ports. Comprehensive managed functions offer configuration and diagnostic options. The Smart Managed Switches are approved for ATEX Zone 2 and Class I Division 2.

With the DLR (Device Level Ring) redundancy mechanism, the 7000 series Advanced Managed Switches offer the option of connecting up to six devices to the ring via a single switch. Thanks to CIP (Common Industrial Protocol), they can also be fully integrated in EtherNet/IP™ networks and configured and diagnosed from the control system. HazLoc certification (Class I, Division 2, Groups A, B, C and D, Hazardous Locations) allows installation directly in the Ex zone.

Leave no room for attack. Distributed safety concepts where networks are protected individually provide maximum security.

The FL MGuard RS 4000 TX/TX-P ([2702259](#)) satisfies the requirements of the process industry as well as the security requirements for a secure OPC classic firewall.

Network security increases process availability

Protection against malware is absolutely essential when linking office networks with process control networks via Ethernet. The mGuard firewall/router solution provides optimum protection for the control technology. Furthermore, effective remote

maintenance via the Internet is possible by means of secure VPN connections to the process control system. The controllable switches increase security with their functions. Additional devices cannot be connected unless a port is enabled.

Solution concept for Ethernet communication networks

In addition to firewalls and WLAN infrastructure, Phoenix Contact offers appropriate surge protection for all types of industrial networks. In addition, a wide range of accessories is available, offering you a complete solution for Ethernet communication.

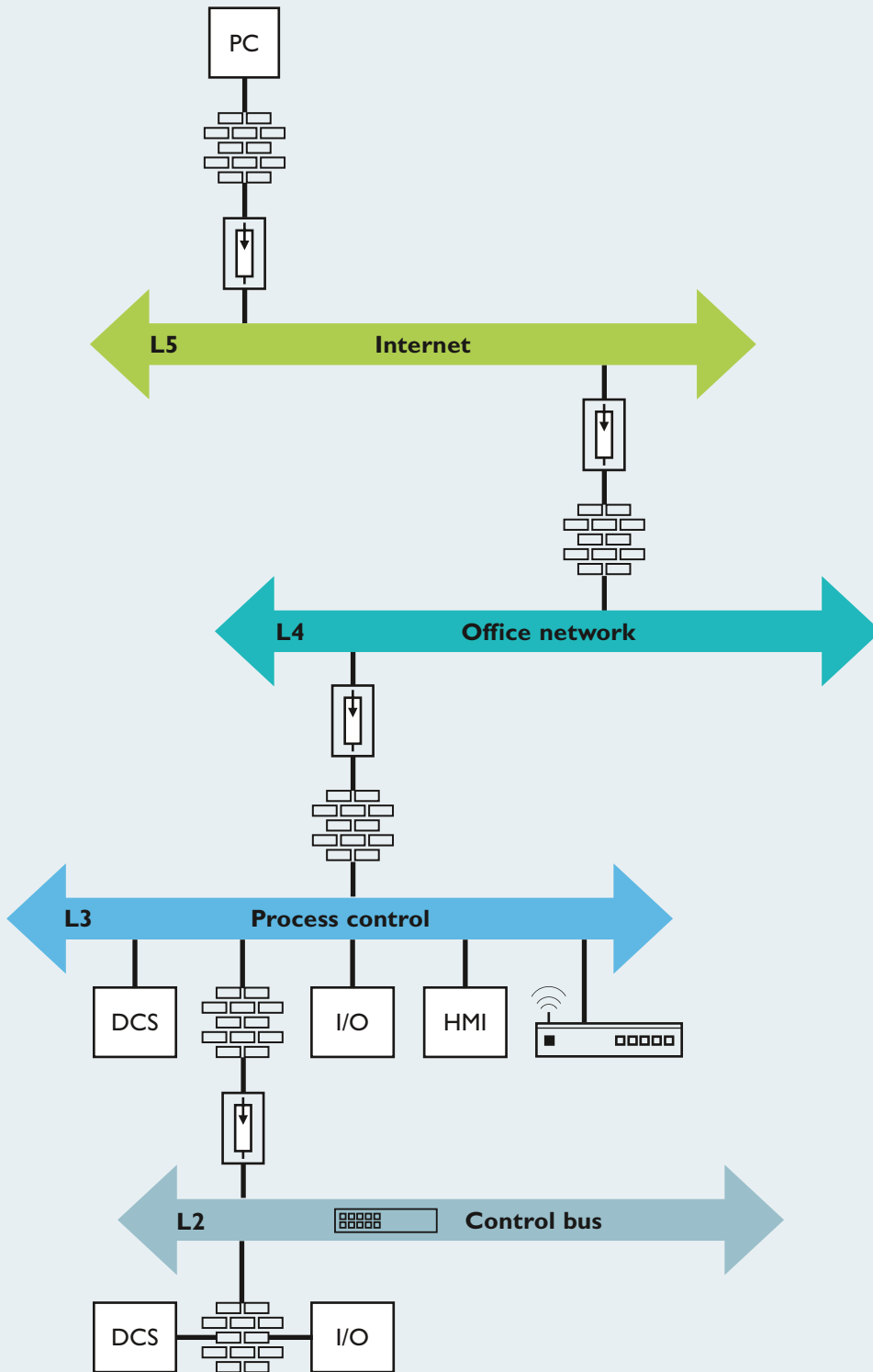

Unmanaged Switches

FL SWITCH SFN 8GT**

Order No. [2891673](#)

FL SWITCH SFN 6GT/2SX**

Order No. [2891952](#)

FL SWITCH SFN 6GT/2LX**

Order No. [2891987](#)

FL SWITCH SFN 6GT/2LX-20

Order No. [2891563](#)

Description

The FL SWITCH SFN ... GT have a wide range of port configurations with fiberglass and copper, as well as functions for standard applications.

Eight ports with redundant input voltage offer transmission speeds of 1 Gbps. Auto negotiation and autocrossing detection simplifies installation and configuration. Other features include transmission distances of up to 20 km, local diagnostics indicators with LEDs, relay contacts for alarm processing of voltage states, and additional cable locking and port blocking. With Ex approval for Zone 2/Class 1 DIV 2, these switches can be installed directly in the Ex zone.

* Extended temperature range:
-40°C to +70°C ** .25°C to +75°C



PRP redundancy modules

FL RED 2003E PRP
Order No. [2701863](#)

FL RED 2001E PRP 2LC
Order No. [2701864](#)

Wireless access point

FL WLAN 5100*
Order No. [2700718](#)

FL WLAN 5101**
Order No. [2701093](#)
• For the USA and Canada

FL WLAN 5102
Order No. [2701850](#)
• For Japan

SD-FLASH 2 GB
Order No. [2988162](#)

Surge protection

DT-LAN-CAT.6+
Order No. [2881007](#)

D-LAN-19"-24 *
Order No. [2838791](#)

D-LAN-19"-20 *
Order No. [2880134](#)

D-LAN-19"-16 *
Order No. [2880147](#)

D-LAN-19"-12 *
Order No. [2880150](#)

D-LAN-19"-8 *
Order No. [2880163](#)

D-LAN-19"-4 *
Order No. [2880176](#)

Accessories

FL CAT6 PATCH 1,0 Cable
Order No. [2832276](#) 1 m

FL CAT5 PATCH 2,0 Cable
Order No. [2832289](#) 2 m

FL CAT5 PATCH 5,0 Cable
Order No. [2832580](#) 5 m

VS-PN-RJ45-5-Q/IP20 RJ45
Order No. [1658435](#) connector

Connection modules for DIN rails
FL-PP-RJ45-LSA 1 slot
Order No. [2901645](#)

FL PF 2TX CAT 6
Order No. [2891068](#)

FL-PP-RJ45-SCC
Order No. [2901642](#)

FL-PP-RJ45-SC
Order No. [2901643](#)

FL-PP-RJ45/RJ45
Order No. [2901646](#)

Energy and process networks require particularly high fault tolerance. The PRP redundancy modules enable parallel redundancy without recovery time in the event of an error and ensure the high availability of the network.

They have an RJ45 port for a terminal device and either two RJ45 ports or 2 LC multimode ports as redundancy ports. Furthermore, the redundancy modules are suitable for use under the harshest ambient conditions in accordance with IEC 61850-3.

Industrial WLAN access points for creating wireless LAN networks or wireless networking of plants outdoors.

Features include maximum security in accordance with IEEE 802.11i with AES encryption, 2.4 GHz and 5 GHz support, high resistance to vibration, shock, and EMI, and a range of several hundred meters. The FL WLAN 5100 also supports a maximum data throughput of up to 300 Mbps.

* ATEX Zone 2
** Class 1 Div 2

DT-LAN-CAT.6+ surge protection can be used for data transmission of up to 10 Gbps.

* Surge protection per port for the 19" control cabinet is available from 4 to 24 RJ24 connections. Grounding is via a gas-filled surge arrester in the housing. Data interfaces in the Ethernet (1000Base-T), token ring, and FDDI/CDDI networks in accordance with Class D/EN 50173 (CAT5e).

You can find a comprehensive range of accessories for Ethernet network technology in our e-shop: patch fields, pre-assembled cabling systems, markings, software, tools, and much more.

Power supplies

Groundbreaking technology for superior system availability

The QUINT POWER product range offers functionality at the highest level:

Power supplies and DC/DC converters with SFB technology reliably switch off faulty current paths in the event of a short circuit. Other loads continue to be supplied without any interruption.

Uninterruptible power supplies with IQ technology calculate the current life expectancy of the power storage and supply the loads with optimum utilization of battery.

Redundancy modules with ACB technology double the service life of a redundant power supply.

The reliability of the power supply is becoming increasingly important since the loads supplied in the process industry are particularly sensitive and downtimes are costly. With this in mind, Phoenix Contact offers a consistent product range for maximum availability:

- Reliable supply and cost-effective selective protection with QUINT POWER
- Use intelligent UPS in the control cabinet with QUINT UPS and optimally supply the PC/IPC with power in the event of mains failure, since IQ technology detects, optimizes, and provides information about the power storage
- Reliably monitor the load current of redundant power supplies with QUINT ORING
- Smart combination: two QUINT POWER power supplies combined with a QUINT ORING module limit any surge voltages that occur to 32 V



Components for your power supply solution

Power supplies – also dip-coated

Single or three-phase, for 12, 24, and 48 V DC with power up to 1000 watts. Also available in dip-coated versions with Ex approval for 100% humidity.

Benefit from the advantages of QUINT POWER devices for DC/DC converters as well: with huge power reserves and preventive function monitoring.

Intelligence for maximum system availability

Uninterruptible power supplies continue to deliver power even in the event of mains failure.

The comprehensive UPS product range for the QUINT UPS series provides DC solutions which, when used in combination with different battery technologies, support a wide range of applications.

Active redundancy module

Monitor the output voltage, load current, decoupling section, and wiring right up to the redundancy module with QUINT ORING modules with approval for the ex area. QUINT DIODE passive redundancy modules are also available.

Surge protection and device circuit breakers

High system availability and safety require a high level of protection against all types of coupling. Surge protection and device circuit breakers safeguard your power supply.

Potential distributors

Designed for up to 250 V/30 A, the potential distributors are suitable for universal use – for both operating voltage and control voltage distribution. Screw or spring-cage connection technology can be selected as required.

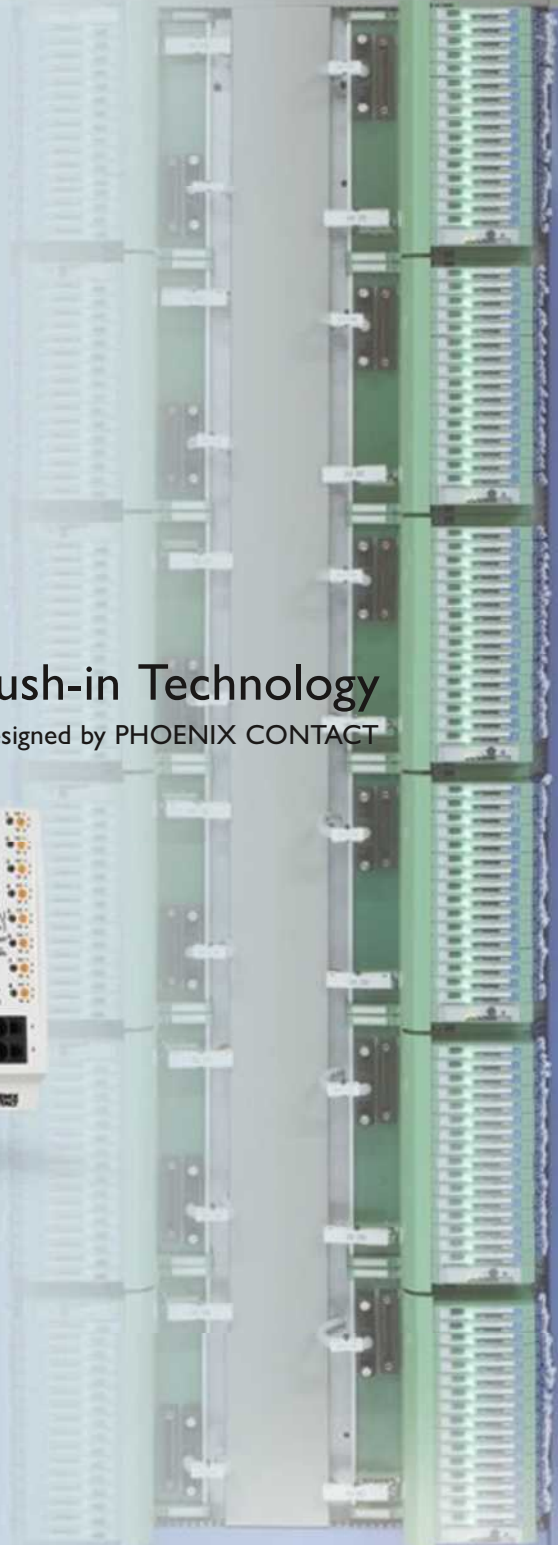
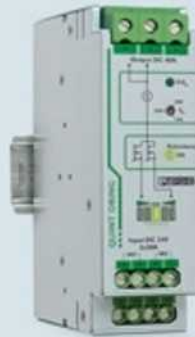

Push-in Technology

Designed by PHOENIX CONTACT

Increased availability thanks to parallel operation

The QUINT POWER power supplies guarantee high functionality and quality. Whether in parallel operation or connected to different phases, the load is reliably supplied even in the event of problems with the input voltage.

Power supplies with protective coating are available specifically for extreme requirements with respect to ambient conditions. These power supplies prevent failure caused by electrochemical migration or corrosion-related creepage currents.

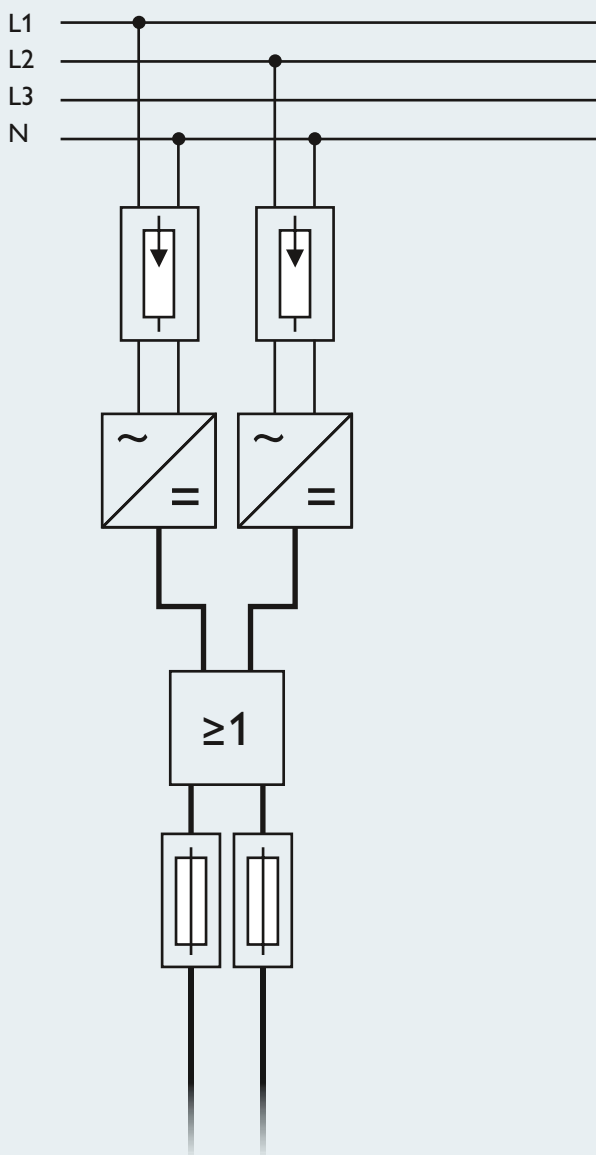

Note about explosion protection

The protective coating provides optimum protection for all components on the PCB. This means that 100% humidity does not present a problem.

In addition to the usual approvals for industrial applications, the modules with protective coating conform to EN 60079-15 and EN 60079-0 (ATEX Directive). They may be installed in the potentially explosive area in which Category 3G equipment is required (II 3 G Ex nA nC IIC T4 Gc). They have also been approved in accordance with IECEx (Ex nA nC IIC T4 Gc). All QUINT POWER devices are approved in accordance with UL standard ANSI/ISA 12.12.01 and satisfy the requirements of Class I, Division 2, Groups A, B, C, and D (Hazardous Locations).

Technical data

Approvals

Nominal input voltage

Nominal output voltage

Output current (POWER BOOST 1.5 times the nom. current, SFB technology 6 times the nom. current)

Number of positions

Nominal current

One-piece/multipartite

Nominal voltage range

Arrester type



Power supplies, single-phase

- QUINT-PS 1AC/24DC/3,5**
Order No. [2866747](#)
- QUINT-PS 1AC/24DC/5**
Order No. [2866750](#)
- QUINT-PS 1AC/24DC/10**
Order No. [2866763](#)
- QUINT-PS 1AC/24DC/20**
Order No. [2866776](#)
- QUINT-PS 1AC/24DC/40**
Order No. [2866789](#)
- QUINT-PS 1AC/12DC/15**
Order No. [2866718](#)
- QUINT-PS 1AC/12DC/20**
Order No. [2866721](#)
- QUINT-PS 1AC/48DC/5**
Order No. [2866679](#)
- QUINT-PS 1AC/48DC/10**
Order No. [2866682](#)
- QUINT-PS 1AC/48DC/20**
Order No. [2866695](#)

Power supplies, with protective coating

- QUINT-PS 1AC/24DC/5/CO**
Order No. [2320908](#)
- QUINT-PS 1AC/24DC/10/CO**
Order No. [2320911](#)
- QUINT-PS 1AC/24DC/20/CO**
Order No. [2320898](#)
- QUINT-PS 3AC/24DC/20/CO**
Order No. [2320924](#)

Device circuit breakers, multi-channel/modular

- CBM E4 24DC/0.5-10A NO-R**
Order No. [2905743](#)
- CBM E8 24DC/0.5-10A NO-R**
Order No. [2905744](#)
- CB TM1 0.5A SFB P**
Order No. [2800835](#)
- CB TM1 2A SFB P**
Order No. [2800837](#)
- CB TM1 4A SFB P**
Order No. [2800839](#)
- CB TM1 6A SFB P**
Order No. [2800841](#)
- CB TM1 8A SFB P**
Order No. [2800842](#)
- CB TM1 10A SFB P**
Order No. [2800843](#)
- CB TM1 12A SFB P**
Order No. [2800844](#)
- CB 1/6-2/4 PT-BE** Base element
Order No. [2800929](#)

Surge protection – device protection

- PLT-SEC-T3-24-FM**
Order No. [2905223](#)
- PLT-SEC-T3-60-FM**
Order No. [2905225](#)
- PLT-SEC-T3-120-FM**
Order No. [2905228](#)
- PLT-SEC-T3-230-FM**
Order No. [2905229](#)

Type 1 and type 2 surge arresters for the main and sub-distribution of the energy supply can be found in our e-shop.

For further versions and device circuit breaker boards, visit phoenixcontact.net/products.

UL Listed UL 508, UL/CUL-UL Recognized UL 60950, ANSI/ISA-12.12.01 Class I, Division 2, Groups A, B, C, D

85 V AC ... 264 V AC / 90 V DC ... 350 V DC

12 / 24 / 48 V DC

3.5 / 5 / 15 / 10 / 20 / 40 A

UL Listed UL 508, UL/CUL-UL Recognized UL 60950, ATEX, IECEx Zone 2

85 V AC ... 264 V AC / 90 V DC ... 350 V DC

24 V DC

5 / 10 / 20 A

CSA, CUL, UL, VDE-PZI

–

–

–

1

0.5 - 16 A

Multipartite/pluggable

Up to 50 V DC

–

CB, CCA, CUL, GOST, KEMA, OEVE, UL, CUL-EX, UL-EX

–

–

–

Multipartite/pluggable

230 V AC

Type 3 arrester (device protection)

Increased availability thanks to two separate networks

QUINT DC/DC converters are used to create a separate power supply with external power storage devices. Should the network supply fail, the DC/DC converter supplies the load from the battery.

Redundancy modules decouple power supplies operating in parallel. If the wiring is also duplicated, a completely redundant solution can be implemented right up to the load. QUINT DIODE modules decouple, while QUINT ORING modules also monitor and control the power supply.

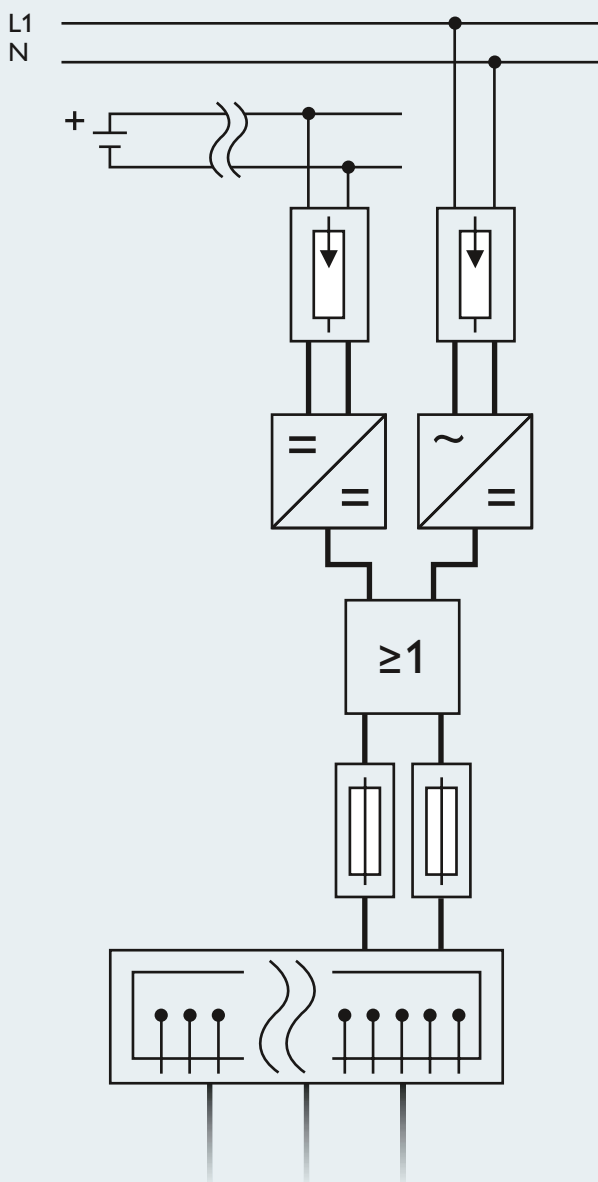

Note on fuse terminal blocks:

The current is determined by the fuse used, the voltage by the selected LED display.



DC/DC converters

QUINT-PS 24DC/24DC/5
Order No. [2320034](#)

QUINT-PS 24DC/24DC/10
Order No. [2320092](#)

QUINT-PS 24DC/24DC/20
Order No. [2320102](#)

QUINT-PS 24DC/12DC/8
Order No. [2320115](#)

QUINT-PS 24DC/48DC/5
Order No. [2320128](#)

QUINT-PS 12DC/12DC/8
Order No. [2905007](#)

QUINT-PS 48DC/48DC/5
Order No. [2905008](#)

QUINT-PS/24DC/24DC/5/CO*
Order No. [2320542](#)

QUINT-PS/24DC/24DC/10/CO*
Order No. [2320555](#)

QUINT-PS/24DC/24DC/20/CO*
Order No. [2320568](#)

Technical data

Approvals	UL Listed UL 508, UL/CUL-UL Recognized UL 60950 *ATEX, IECEx
Input voltage range	9 V DC ... 56 V DC
Nominal output voltage	12 / 24 / 48 V DC
Output current of DC/DC converters (POWER BOOST 1.5 times the nominal current, SFB technology 6 times the nominal current)	5 / 8 / 10 / 20 A
Output current of redundancy modules	—
Number of positions	—
Connection technologies	—
Nominal voltage U_N	—
Maximum total current per potential	—
Potential connections	—
Width	—

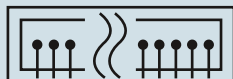

Redundancy modules

- QUINT-ORING 24DC/2x10/1x20***
Order No. [2320173](#)
- QUINT-ORING 24DC/2x20/1x40***
Order No. [2320186](#)
- QUINT-ORING 24DC/2x40/1x80**
Order No. [2902879](#)
- QUINT-DIODE 12-24DC/2x20/1x40***
Order No. [2320157](#)
- QUINT-DIODE 48DC/2x20/1x40***
Order No. [2320160](#)

Potential distributors

- VIP-2/SC/PDM-2/16**
Order No. [2315256](#)
- VIP-2/SC/PDM-2/24**
Order No. [2315269](#)
- VIP-2/SC/PDM-2/32**
Order No. [2315272](#)
- UMK-PVB 2/16/ZFKDS**
Order No. [2302353](#)
- UMK-PVB 2/24/ZFKDS**
Order No. [2302366](#)
- UMK-PVB 2/32/ZFKDS**
Order No. [2302379](#)
- UMK-PVB 2/48/ZFKDS**
Order No. [2302382](#)

Fuse terminal blocks

- UT 4-HESI (5X20)**
Order No. [3046032](#)
- UT 4-HESILED 24 (5X20)**
Order No. [3046090](#)
- UT 4-HESILED 60 (5X20)**
Order No. [3046126](#)
- UT 6-HESI (6,3X32)**
Order No. [3046401](#)
- UT 6-HESILED 24 (6,3X32)**
Order No. [3046414](#)
- UT 6-HESILED 60 (6,3X32)**
Order No. [3046427](#)

For further fuse terminal blocks see page 42 and visit phoenixcontact.net/products.

Electronic device circuit breakers

- EC-E1 8.0 A**
Order No. [0903029](#)
- EC-E1 10 A**
Order No. [0903030](#)
- EC-E1 12 A**
Order No. [0903031](#)
- EC-E4 8.0 A**
Order No. [0903037](#)
- EC-E4 10 A**
Order No. [0903038](#)
- EC-E4 12 A**
Order No. [0903039](#)
- EC-E 8.0 A 24 V DC**
Order No. [0903047](#)
- EC-E 10 A 24 V DC**
Order No. [0903048](#)
- EC-E 12 A 24 V DC**
Order No. [0903049](#)

UL Listed UL 508, UL/CUL-UL
Recognized UL 60950, *CUL-EX LIS,
IECEX, KEMA-EX, UL-EX LIS, ATEX

10 V DC ... 56 V DC

12 / 24 / 48 V DC

–

1 x 20 / 1 x 40 / 1 x 80 A

–

–

–

–

–

–

–

CUL, UL, CSA/GOST

–

–

–

–

8 - 24

Screw or spring-cage connection

250 V AC/DC

≥ 30 A

Per potential (P1, P2) 2 power terminals/
up to 24 distributor terminals

50 mm - 135 mm

CB, CSA, CUL, DNV, GL, KEMA, LR,
RS, UL

–

–

–

–

–

Screw connection

24 V - 630 V

–

–

–

–

UL Ex, II 3G Ex nA IIB T4 Gc X

–

–

–

–

–

Screw connection

24 V DC (18 V DC ... 32 V DC)

–

–

–

–

Increased availability thanks to uninterruptible power supply

QUINT UPS uninterruptible power supplies bridge mains breakdown and failure. The IQ technology determines all relevant power storage states. This ensures the transparency required to guarantee the stability of the supply and optimum use of the power storage at all times.

- QUINT UPS for DC applications in combination with external power storage devices
- QUINT UPS with integrated power storage based on VRLA (valve regulated lead acid) technology

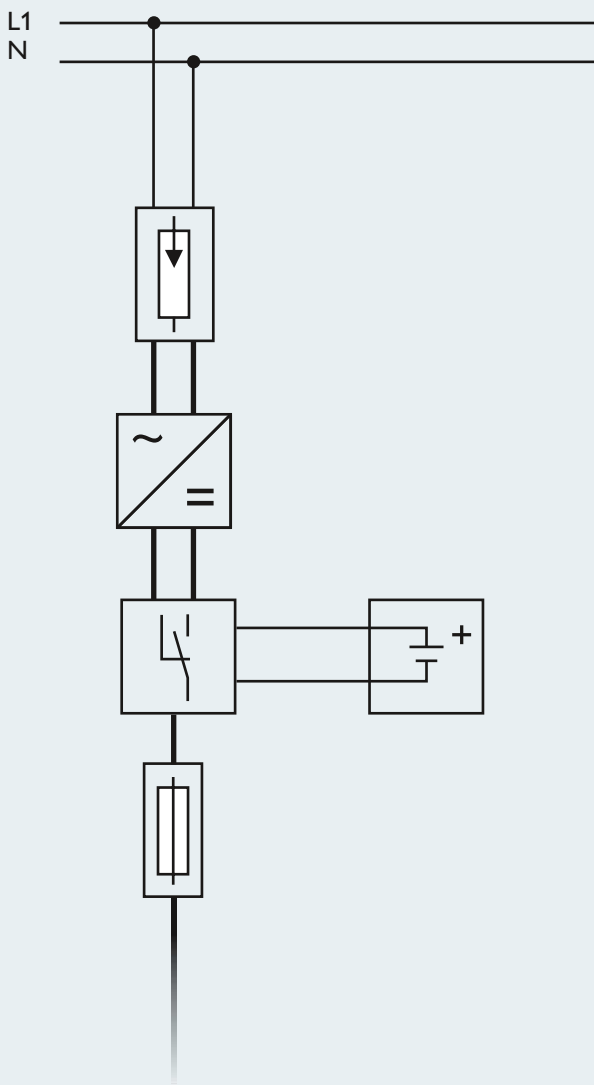

The various storage media feature a wide range of different properties: long service life or very long buffer time, no maintenance or use at extreme temperatures.

Type	Buffer time (typical)	Temperature	Service life at 20 °C	Service life at 50 °C
UPS-CAP...	< 5 min.	-40 to +60 °C	> 20 years	8 years
UPS-BAT/LI-ION...	> 40 min.	-20 to +58 °C	15 years	2 years
UPS-BAT/VRLA-WTR...	> 5 h	-25 to +60 °C	12 years	1,5 years
UPS-BAT/VRLA...	> 8 h	0 to 40 °C	6 to 9 years	1 year

Buffer times for DC UPS modules

Select your **UPS-BAT** for 24 V DC applications here.
Example: 20 A needs to be buffered for 10 minutes



→ QUINT-DC-UPS/24DC/20A and UPS-BAT/VRLA/24DC/7.2AH

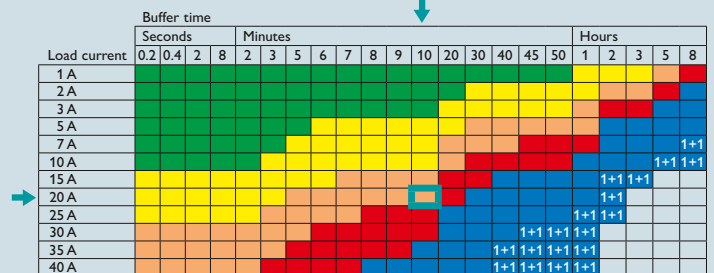

1+1: in this case, two rechargeable batteries with the same capacity are required. The values are based on an ambient temperature of +20°C.

- **UPS-BAT/VRLA/24DC/1.3AH**, Order No. [2320296](#)
- **UPS-BAT/VRLA/24DC/3.4AH**, Order No. [2320306](#)
- **UPS-BAT/VRLA/24DC/7.2AH**, Order No. [2320319](#)
- **UPS-BAT/VRLA/24DC/12AH**, Order No. [2320322](#)
- **UPS-BAT/VRLA/24DC/38AH**, Order No. [2320335](#)



Charging cycles at 20 °C	Weight (standardized)
> 500,000	0,4 kg
7,000	0,5 kg
300	1,3 kg
250	1 kg

Uninterruptible power supplies

- QUINT-UPS 24DC/24DC/5**
Order No. [2320212](#)
- QUINT-UPS 24DC/24DC/10**
Order No. [2320225](#)
- QUINT-UPS 24DC/24DC/20**
Order No. [2320238](#)
- QUINT-UPS 24DC/12DC/40**
Order No. [2320241](#)
- QUINT-UPS 24DC/12DC/5/24DC/10**
Order No. [2320461](#)
- QUINT-UPS 24DC/24DC/5/1,3AH**
Order No. [2320254](#)
- QUINT-UPS 24DC/24DC/10/3,4AH**
Order No. [2320267](#)

Power storage

- UPS-BAT/VRLA/24DC/1,3AH**
Order No. [2320296](#)
- UPS-BAT/VRLA/24DC/3,4AH**
Order No. [2320306](#)
- UPS-BAT/VRLA/24DC/7,2AH**
Order No. [2320319](#)
- UPS-BAT/VRLA/24DC/12AH**
Order No. [2320322](#)
- UPS-BAT/VRLA/24DC/38AH**
Order No. [2320335](#)
- UPS-BAT/VRLA-WRT/24DC/13AH**
Order No. [2320416](#)
- UPS-BAT/VRLA-WRT/24DC/26AH**
Order No. [2320429](#)
- UPS-BAT/LI-ION/24DC/120 WH**
Order No. [2320351](#)
- UPS-CAP/24DC/10A/10KJ**
Order No. [2320377](#)
- UPS-CAP/24DC/20A/20KJ**
Order No. [2320380](#)

Accessories for UPS

- IFS-RS232-DATACABLE**
Order No. [2320490](#)
- IFS-USB-DATACABLE**
Order No. [2320500](#)
- IFS-OPEN-END-DATACABLE**
Order No. [2320450](#)
- IFS-MINI-DIN-DATACABLE**
Order No. [2320487](#)
- UPS-CONF**
Order No. [2320403](#)
- IFS-CONFSTICK**
Order No. [2986122](#)

Technical data

Approvals	UL Listed UL 508, UL/CUL-UL Recognized UL 60950	
Nominal input voltage	24 V DC; 120 V AC / 230 V AC	24 V DC
Output voltage range	18 ... 30 V DC; 96 ... 144 V AC / 184 ... 264 V AC	
Output current of DC-UPS	5 / 10 / 20 / 40 A	
Nominal output current	7.5 / 15 / 27 / 45 A	
POWER BOOST	30 / 60 / 120 / 215 A	
SFB technology		
Output current of AC-UPS	2.2 A	
Nominal output current	2.7 A	
POWER BOOST		

Connection technology and marking

With the unique terminal block system from Phoenix Contact, the user is free to choose the connection technology. Whether you opt for screw, spring-cage, push-in or fast connection technology, all of these connection technologies can be freely combined with each other using the same accessories thanks to the double bridge shaft and are tested in accordance with NE 95.

Optimize all of the processes involved in the setup, installation, and maintenance of your control cabinets and systems in the field. We can help you achieve this with optimally coordinated products from our marking, tool, and mounting material ranges.

CLIP PROJECT

For detailed information on CLIP PROJECT planning and marking software as well as our value added services, see from page 142.

Push-in Technology

Designed by PHOENIX CONTACT



Connection technology, marking, tools, and mounting material

Connection technology for marshalling

Depending on the application – feed-through or knife disconnection – you can choose between, and combine, single and multi-level terminal blocks. The suitable partition plates for separating the Ex e and Ex i areas are documented in the “Accessories” section.

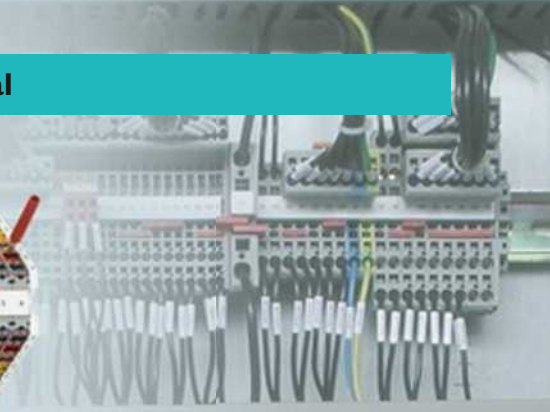

Connection technology for power distribution

Terminal block bases with bolt, screw, and push-in connection technology are available for power distribution and for connecting large loads up to 500 A with a maximum of 1500 V.

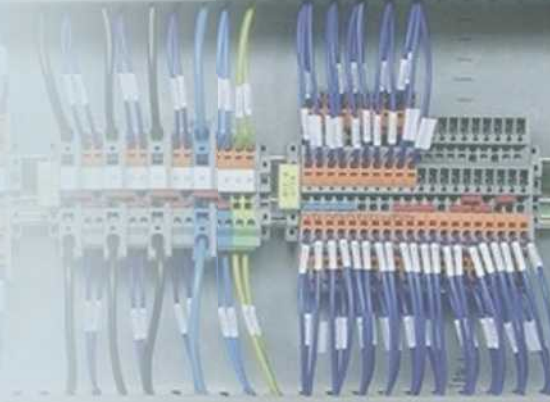

Marking systems

MARKING system provides the perfect solutions for terminal, conductor, cable, and device marking. It places at your disposal the CLIP PROJECT planning and marking software, printers with various printing systems, and a wide variety of marking materials.



Tools and mounting material

TOOL fox is the complete range of professional processing and measuring tools. Designed for use in all processes, the tools and automatic devices impress with their optimum handling and superior quality.

CABINET add-on offers everything you need for the fast construction of switchgear. Shield terminals for EMC-compliant wiring complete the range of products.



Marshalling panels and patchboards

You can save a lot of space in any control cabinet using marshalling panels and patchboards with high packing density. Available in various colors and with various numbers of channels, these highly flexible series can be adapted to the specific marshalling requirements, thereby ensuring a clean structure for the signal wiring. Test connections for measurements during startup and maintenance round off the profile for this terminal range.



You can find the entire range of marshalling panels and patchboards for use in process technology and process engineering as well as additional accessories at phoenixcontact.net/products.



Color coding in up to eleven colors for clear identification of the wiring levels

Technical data

Width / length / height [mm]

Rated voltage [V]

Nominal current [A] / cross section [mm²]

Cross section range [AWG]



Individual color coding of the terminal points

Technical data

Width / length / height [mm]

Rated voltage [V]

Nominal current [A] / cross section [mm²]

Cross section range [AWG]



Marshalling panel

PTRV 4 /WH
Order No. 3270115
PTRV 4 /RD
Order No. 3270121
PTRV 4 BU/WH
Order No. 3270119
PTRV 4 BU/RD
Order No. 3270120

Marshalling panel

PTRV 4-PV /BK
Order No. 3270125
PTRV 4-PV BU/BK
Order No. 3270126
PTRV 4-FE /YEBK
Order No. 3270130
PTRV 4-FE /BKYE
Order No. 3270131

Marshalling panel

PTRV 8 /WHRD
Order No. 3270133
PTRV 8 /RDWH
Order No. 3270137
PTRV 8 BU/WHRD
Order No. 3270134
PTRV 8 BU/RDWH
Order No. 3270135

Marshalling panel

PTRV 8-PV /BK
Order No. 3270142
PTRV 8-PV BU/BK
Order No. 3270145
PTRV 8-FE /YEBK
Order No. 3270148
PTRV 8-FE /BKYE
Order No. 3270149

8.3 / 64 / 55.5
250
10 A / 1.5 mm²
26 - 12

8.3 / 64 / 55.5
250
17.5 A / 1.5 mm²
26 - 12

8.3 / 100 / 87.5
250
8 A / 1.5 mm²
26 - 12

8.3 / 100 / 87.5
250
17.5 A / 1.5 mm²
26 - 12



Marshalling patchboard

PTMC 1,5-3 /GY
Order No. 3270300
PTMC 1,5-3 /WH
Order No. 3270301
PTMC 1,5-2 /GY *
Order No. 3270302
PTMC 1,5-2 /WH *
Order No. 3270303

Marshalling patchboard

PTMC 1,5/32-3
Order No. 3270310
PTMC 1,5/32-3 /BU
Order No. 3270312
PTMC 1,5/32-3 19Z *
Order No. 3270311
PTMC 1,5/32-3 /BU 19Z *
Order No. 3270313

Marshalling patchboard

PTMC 1,5/48-3
Order No. 3270318
PTMC 1,5/48-3 /BU
Order No. 3270320
PTMC 1,5/48-3 19Z *
Order No. 3270319
PTMC 1,5/48-3 /BU 19Z *
Order No. 3270321

Marshalling patchboard

PTMC 1,5/80-3
Order No. 3270324
PTMC 1,5/80-3 /BU
Order No. 3270326
PTMC 1,5/80-3 19Z *
Order No. 3270325
PTMC 1,5/80-3 /BU 19Z *
Order No. 3270327

11 / 12.2 / 30 // *11 / 8.6 / 30
500
17.5 A / 1.5 mm²
26 - 12

44 / 102 / 30 // *44 / 111 / 30
500
17.5 A / 1.5 mm²
26 - 12

66 / 102 / 30 // *66 / 111 / 30
500
17.5 A / 1.5 mm²
26 - 12

110 / 102 / 30 // *110 / 111 / 30
500
17.5 A / 1.5 mm²
26 - 12

Feed-through terminal blocks for marshalling and field distribution

Terminal blocks from Phoenix Contact satisfy all requirements. The compact terminal blocks with an overall width from just 3.5 mm fit in any control cabinet. Single terminal blocks and double-level terminal blocks in many different colors and sizes support a wide range of possible applications in the field of signaling.

Designed in accordance with Ex i (EN 60079-11) and approved in accordance with Ex e (EN 60079-07), all terminal blocks satisfy the requirements of process technology. The range of terminal blocks is rounded off by comprehensive documentation of approvals and installation notes.

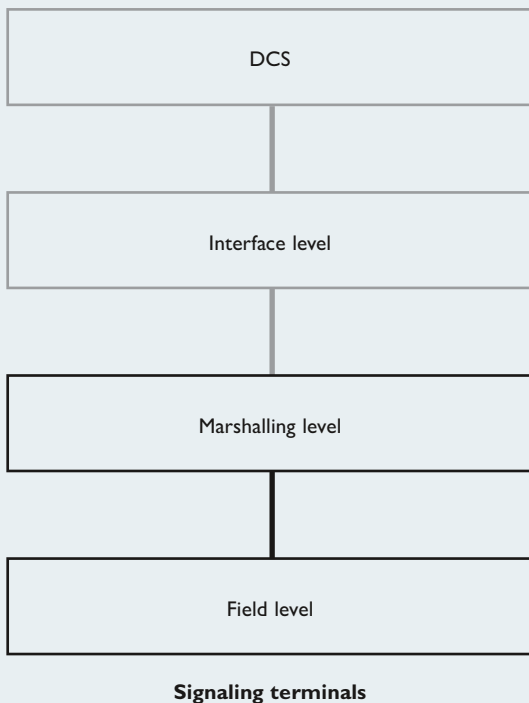

You can find the entire range of feed-through terminal blocks for process technology and process engineering as well as additional accessories, information, and full technical data at phoenixcontact.net/products.

Technical data

Approvals¹
Width / length / height [mm]
Rated voltage [V]
Nominal current [A] / cross section [mm²]
Cross section range [AWG]

Technical data

Approvals¹
Width / length / height [mm]
Rated voltage [V]
Nominal current [A] / cross section [mm²]
Cross section range [AWG]

¹ Further approvals can be found at phoenixcontact.net/products



Feed-through terminal block with screw connection

UT 2,5
Order No. [3044076](#)
UT 2,5 BU
Order No. [3044089](#)

ATEX, cULus Recognized, EAC Ex, IECEx
5.2 / 47.7 / 47.5
1000
24 A / 2.5 mm²
26 - 12

Feed-through terminal block with spring-cage connection

ST 2,5
Order No. [3031212](#)
ST 2,5 BU
Order No. [3031225](#)

ATEX, EAC Ex, IECEx
5.2 / 48.5 / 36.5
800
24 A / 2.5 mm²
28 - 12

Feed-through terminal block with push-in connection

PT 1,5/S
Order No. [3208100](#)
PT 1,5/S BU
Order No. [3208126](#)

ATEX, EAC Ex, IECEx
3.5 / 45 / 32
500
17.5 A / 1.5 mm²
26 - 14

Feed-through terminal block with fast connection

QTC 1,5
Order No. [3205019](#)
QTC 1,5 BU
Order No. [3205022](#)

ATEX, EAC Ex, IECEx
5.2 / 58.8 / 39.3
800
17.5 A / 1.5 mm²
24 - 16



Double-level terminal block with screw connection

UTTB 2,5
Order No. [3044636](#)
UTTB 2,5 BU
Order No. [3044649](#)
UTTB 2,5-PV
Order No. [3044652](#)

ATEX, cULus Recognized, EAC Ex, IECEx
5.2 / 69.9 / 65
500
24 A / 2.5 mm²
26 - 12

Double-level terminal block with spring-cage connection

STTB 2,5
Order No. [3031270](#)
STTB 2,5 BU
Order No. [3031283](#)
STTB 2,5-PV
Order No. [3031539](#)

ATEX, EAC Ex, IECEx
5.2 / 67.5 / 47.5
500
22 A / 2.5 mm²
28 - 12

Double-level terminal block with push-in connection

PTTB 1,5/S
Order No. [3208511](#)
PTTB 1,5/S BU
Order No. [3208524](#)
PTTB 1,5/S-PV
Order No. [3208540](#)

ATEX, EAC Ex, IECEx
3.5 / 65.4 / 42.6
500
16 A / 1.5 mm²
26 - 14

Double-level terminal block with fast connection

QTTCB 1,5
Order No. [3205116](#)
QTTCB 1,5 BU
Order No. [3205129](#)
QTTCB 1,5-PV
Order No. [3205153](#)

ATEX, EAC Ex, IECEx
5.2 / 99.6 / 49.4
500
17.5 A / 1.5 mm²
24 - 16

Ground terminals for marshalling and field distribution

In addition to marshalling process signals, grounding is also necessary to ensure the signal quality and therefore error-free operation of the system.

Phoenix Contact offers a comprehensive range of ground terminals with snap-on PE foot for the various connection technologies.

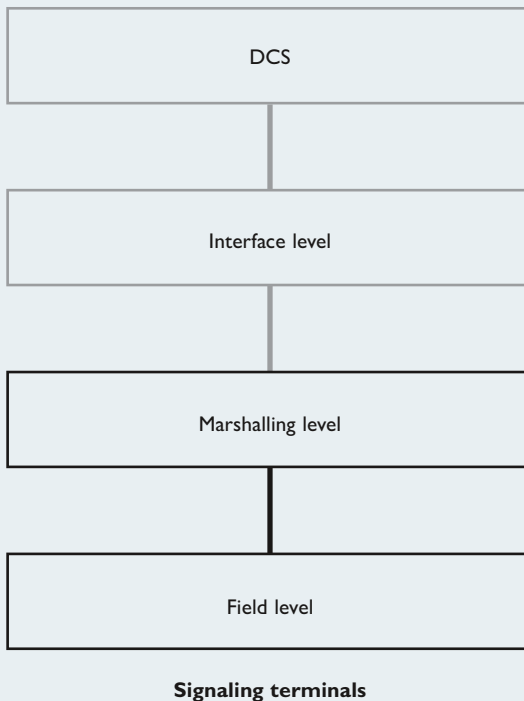

You can find the entire range of ground terminals for process technology and process engineering as well as additional accessories, information, and full technical data at phoenixcontact.net/products.

Technical data

Approvals¹

Width / length / height [mm]

Rated cross section [mm²]

Cross section range [AWG]

Technical data

Approvals¹

Width / length / height [mm]

Rated cross section [mm²]

Cross section range [AWG]

¹ Further approvals can be found at phoenixcontact.net/products



Ground terminal with screw connection

Ground terminal with spring-cage connection

Ground terminal with push-in connection

Ground terminal with fast connection

UT 2,5-PE
Order No. [3044092](#)

ST 2,5-PE
Order No. [3031238](#)

PT 1,5/S-PE
Order No. [3208139](#)

QTC 1,5-PE
Order No. [3205035](#)

ATEX, cULus Recognized, EAC Ex, IECEx
5.2 / 47.7 / 47.5
2.5
26 - 12

ATEX, EAC Ex, IECEx
5.2 / 48.5 / 36.5
2.5
28 - 12

ATEX, EAC Ex, IECEx
3.5 / 45 / 32
1.5
26 - 14

ATEX, EAC Ex, IECEx
5.2 / 58.8 / 39.3
1.5
24 - 16



Double-level ground terminal with screw connection

Double-level ground terminal with spring-cage connection

Double-level ground terminal with push-in connection

Double-level ground terminal with fast connection

UTT 2,5-PE
Order No. [3044665](#)

STTB 2,5-PE
Order No. [3036026](#)

PTTB 1,5/S-PE
Order No. [3208537](#)

QTTCB 1,5-PE
Order No. [3205132](#)

ATEX, cULus Recognized, EAC Ex, IECEx
5.2 / 69.9 / 65
2.5
26 - 12

ATEX, EAC Ex, IECEx
5.2 / 67.5 / 47.5
2.5
28 - 12

ATEX, EAC Ex, IECEx
3.5 / 65.4 / 42.6
1.5
26 - 14

ATEX, EAC Ex, IECEx
5.2 / 99.6 / 49.4
1.5
24 - 16

Knife disconnect terminal blocks for marshalling

Single-level or double-level terminal blocks with knife disconnection are used for marshalling and isolating input and output signals. Measurements can be taken on the signal path using integrated test sockets.



You can find the entire range of knife disconnect terminal blocks for process technology and process engineering as well as additional accessories (including those relating to testing and measurement) plus additional information and full technical data at phoenixcontact.net/products.

Technical data

Width / length / height [mm]
Rated voltage [V]
Nominal current [A] / cross section [mm²]
Cross section range [AWG]

Technical data

Width / length / height [mm]
Rated voltage [V]
Nominal current [A] / cross section [mm²]
Cross section range [AWG]



Knife disconnect terminal block with screw connection

UT 2,5-MT
Order No. 3046362
UT 2,5-MT BU
Order No. 3046553

5.2 / 57.8 / 49.1
400
20 A / 2.5 mm²
26 - 12

Knife disconnect terminal block with spring-cage connection

ST 2,5-MT
Order No. 3036343
ST 2,5-MT BU
Order No. 3037818

5.2 / 60.5 / 36.5
400
20 A / 2.5 mm²
28 - 12

Knife disconnect terminal block with push-in connection

PT 1,5/S-MT
Order No. 3210301
PT 1,5/S-MT BU
Order No. 3210302

3.5 / 58.9 / 32
400
10 A / 1.5 mm²
26 - 14

Knife disconnect terminal block with fast connection

QTC 1,5-MT
Order No. 3205103
QTC 1,5-MT BU
Order No. 3205213

5.2 / 76.4 / 39.3
400
17.5 A / 1.5 mm²
24 - 16



Knife disconnect double-level terminal with screw connection

UTTB 2,5-MT-P/P
Order No. 3044640
UTTB 2,5-MT-P/P BU
Order No. 3044641

5.2 / 69.9 / 65
400
22 A / 2.5 mm²
26 - 12

Knife disconnect double-level terminal with screw connection

UTT 2,5-2MT-P/P
Order No. 3044670
UDMTK 5-P/P BU
Order No. 3101113
UDMTKB 5-P/P
Order No. 3024478
UTT 2,5-2MT-P/P BU
Order No. 3044671

5.2 / 80.1 / 65
400
16 A / 2.5 mm²
26 - 12

Function terminal block with PE foot

PTT 1,5/S-2MT
Order No. 3210351
PTT 2,5-2MT BU
Order No. 3210265

3.5 / 86 / 42.6
400
9 A / 1.5 mm²
26 - 14

Knife disconnect double-level terminal with push-in connection

PTTBS 2,5-2MTB
Order No. 3210400
PTTBS 2,5-2MTB BU
Order No. 3210401

5.2 / 127.5 / 64.3
400
16 A / 2.5 mm²
26 - 12

Fuse and function terminal blocks

Single and multi-level fuse and function terminal blocks are suitable for use in applications that require Ex approval. They offer a single-sided PE connection, a feed-through level, plus a level with safety lever. There are also versions with disconnect knife or standard disconnect zone.



You can find the entire range of terminal blocks for process technology and process engineering as well as additional accessories (including those relating to testing and measurement) at phoenixcontact.net/products.

Note on fuse terminal blocks:

The current is determined by the fuse used, the voltage by the selected LED display.

Technical data

Width / length / height [mm]

Rated voltage [V]

Nominal current [A] / cross section [mm²]

Cross section range [AWG]



Approvals¹

Width / length / height [mm]

Rated voltage [V]

Nominal current [A] / cross section [mm²]

Cross section range [AWG]

¹ Further approvals can be found at phoenixcontact.net/products



Lever-type fuse terminal block with screw connection

UT 4-HESI (5 x 20)
Order No. 3046032

UT 4-HESILED 24 (5 x 20)
Order No. 3046090

UT 4-HESILED 60 (5 x 20)
Order No. 3046126

UT 4-HESILA 250 (5 x 20)
Order No. 3046100

Lever-type fuse terminal block with spring-cage connection

ST 4-HESI (5 x 20)
Order No. 3036369

ST 4-HESILED 24 (5 x 20)
Order No. 3036547

ST 4-HESILED 60 (5 x 20)
Order No. 3036550

ST 4-HESILA 250 (5 x 20)
Order No. 3036563

Lever-type fuse terminal block with push-in connection

PT 4-HESI (5X20)
Order No. 3211861

PT 4-HESILED 24 (5X20)
Order No. 3211903

PT 4-HESILED 60 (5X20)
Order No. 3207908

PT 4-HESILA 250 (5X20)
Order No. 3211907

Lever-type fuse terminal block with fast connection

QTC 2,5-HESI (5 x 20)
Order No. 3050293

QTC 2,5-HESILED 24 (5X20)
Order No. 3050374

QTC 2,5-HESILED 60 (5X20)
Order No. 3050390

QTC 2,5-HESILED 250 (5X20)
Order No. 3050387

6.2 / 57.8 / 73
24 - 500
6.3 A / 4 mm²
26 - 10

6.2 / 61.5 / 62.5
24 - 500
6.3 A / 4 mm²
28 - 10

6.2 / 56 / 62.5
24 - 500
6.3 A / 4 mm²
24 - 10

6.2 / 82.5 / 64.9
24 - 500
6.3 A / 2.5 mm²
20 - 14



Fuse terminal block with PE foot

UT 4-PE/L/HESI (5x20)
Order No. 3214320

UT 4-PE/L/HESILED 24 (5x20)
Order No. 3214321

Basic terminal block for fuse plugs

UT 4-TG-EX
Order No. 3046143

UT 4-TG-P/P-EX
Order No. 3046169

Function terminal block with PE foot

UT 4-PE/MT
Order No. 3070011

UT 4-PE/MT P/P
Order No. 3046140

Knife disconnect terminal with screw connection

UT 4-MT-EX
Order No. 3046141

UT 4-MT-P/P-EX
Order No. 3046173
Ex: u) X

cULus Recognized, IECEx, ATEX
6.2 / 92.7 / 88.9
24 - 500
6.3 A / 4 mm²
26 - 10

CSA, cULus Recognized, IECEx, ATEX
6.2 / 57.8 / 47.5
500
20 A / 4 mm²
26 - 10

CSA, cULus Recognized
6.2 / 70.8 / 49.1
500
20 A / 4 mm²
26 - 10

CSA, cULus Recognized, IECEx, ATEX
6.2 / 57.8 / 49.1
500
20 A / 4 mm²
26 - 10

Connection terminal blocks for power distribution and motors

The screw and push-in connection terminal blocks are characterized in particular by their space-saving design and gas-tight, maintenance-free contacts. High-current terminal blocks as single terminal blocks or as 3 to 5-pos. terminal block bases with flange for direct mounting are available in both connection technologies. A DIN rail version of the terminal blocks is, of course, also available. Designed and approved in accordance with Ex e (EN 60079-07), these terminal blocks satisfy the requirements of process technology. The range of terminal blocks is rounded off by comprehensive documentation of approvals and installation notes.

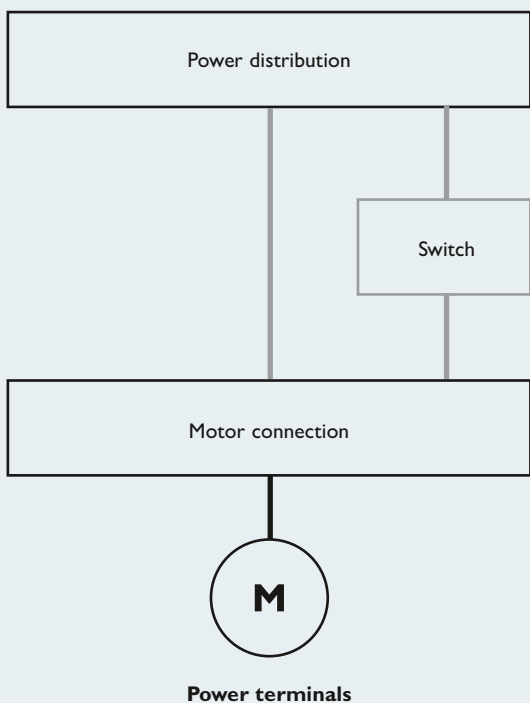

You can find the entire range of connection terminal blocks for power distribution and motors in process technology and process engineering at phoenixcontact.net/products.

Push-in Technology

Designed by PHOENIX CONTACT

Description

Width / length / height [mm]
 Rated voltage [V]
 Nom. current [A] / cross section [mm²]
 Cross section range [AWG]



High-current terminal for direct mounting with screw connection

UKH 50-F
 Order No. [3247019](#)
UKH 50-3L-F*
 Order No. [3076638](#)

Technical data

Width / length / height [mm]	20 / 103.4 / 76 // *60 / 103.4 / 76
Rated voltage [V]	1000
Nom. current [A] / cross section [mm ²]	150 A / 50 mm ²
Cross section range [AWG]	6 - 2/0

*Terminal block bases, 3-pos.



High-current terminal for direct mounting with push-in connection

High-current terminal for direct mounting with push-in connection

High-current terminal for direct mounting with push-in connection

High-current terminal for direct mounting with push-in connection

PTPOWER 35-F
Order No. [3212078](#)

PTPOWER 35-3L-F*
Order No. [3212072](#)

PTPOWER 50-F
Order No. [3260061](#)

PTPOWER 50-3L-F*
Order No. [3260057](#)

PTPOWER 95-F
Order No. [3260133](#)

PTPOWER 95-3L-F*
Order No. [3260121](#)

PTPOWER 150-F
Order No. [3215030](#)

PTPOWER 150-3L-F*
Order No. [3215033](#)

16 / 91.6 / 62.3 // *48 / 91.6 / 62.3
1000
125 A / 35 mm²
10 - 2

20 / 101 / 105 // *60 / 101 / 105
1500
150 A / 50 mm²
8 - 2/0

25 / 139.1 / 108.7 // *75 / 139.1 / 108.7
1500
232 A / 95 mm²
4 - 3/0

31 / 150 / 108.3 // *93 / 150 / 108.3
1500
309 A / 150 mm²
-



High-current terminal for direct mounting with screw connection

High-current terminal for direct mounting with screw connection

High-current terminal for direct mounting with screw connection

High-current terminal for direct mounting with screw connection

UKH 70-F
Order No. [3247051](#)

UKH 70-3L-F*
Order No. [3076484](#)

UKH 95-F
Order No. [3247022](#)

UKH 95-3L-F*
Order No. [3076497](#)

UKH 150-F
Order No. [3247035](#)

UKH 150-3L-F*
Order No. [3076507](#)

UKH 240-F
Order No. [3247048](#)

UKH 240-3L-F*
Order No. [3076510](#)

20.3 / 103.4 / 80 // *60.9 / 103.4 / 80
1000
192 A / 70 mm²
4 - 3/0

25 / 118.8 / 90 // *75 / 118.8 / 90
1000
232 A / 95 mm²
4 - 3/0

31 / 136.1 / 111 // *93 / 136.1 / 111
1000
309 A / 150 mm²
2 - 300 kcmil

36 / 136.1 / 124 // *108 / 136.1 / 124
1000
415 A / 240 mm²
2 / 0 - 500 kcmil

Terminal block accessories and partition plates

In addition to the comprehensive range of terminal blocks, Phoenix Contact also offers many useful accessories for your process automation applications. Along with test accessories and switching locks for knife disconnect terminal blocks which prevent devices from being switched on again unintentionally, the partition plates for ensuring the required air clearances and creepage distances are a particular highlight here.

Should you also wish to use the PTMC marshalling patchboards on a DIN rail instead of the rackmount installation, Phoenix Contact offers the appropriate adapter to do this in the form of a marshalling patchboard holder.



Optional snap-on adapters enable easy mounting on standard DIN rails or direct mounting on panel cutouts or 19" racks.

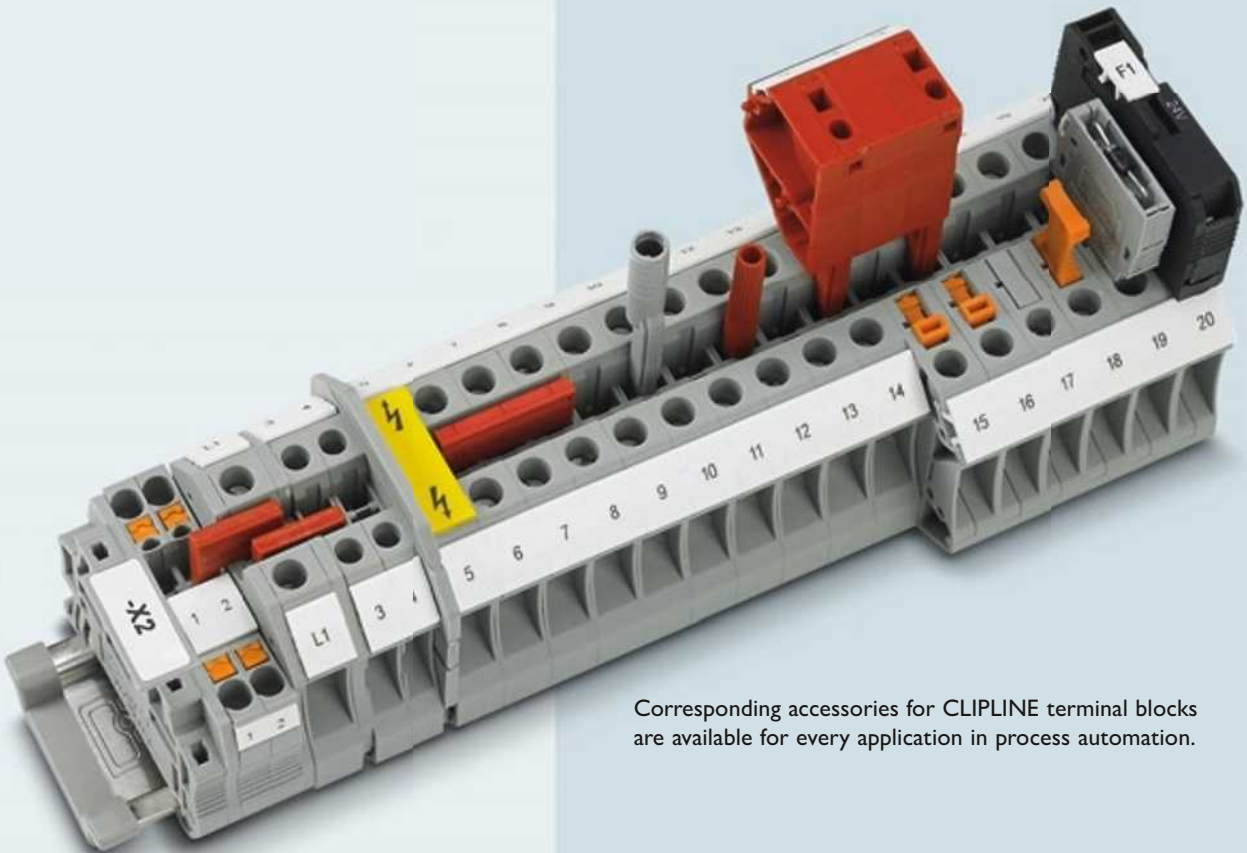

Corresponding accessories for CLIPLINE terminal blocks are available for every application in process automation.



Marsh. patchboard holder

DF-PTMC-NS
Order No. 3270403



Partition plate

TP-UK
Order No. 3003046
TPN-UK
Order No. 3003062
TPNS-UK
Order No. 0706647



Partition plate

TP-BK/MBK
Order No. 0801791
TP-MBK 6/E
Order No. 0554019



Partition plate

TP-KDS/GKDS-EX
Order No. 1701379



Test plug and test adapter

PS-5
Order No. 3030983
MPS-MT
Order No. 201744
PAI-4
Order No. 3030925



Switching lock

S-MT
Order No. 3247954



Fuse plug

P-FU 5X20-EX
Order No. 3036807
P-FU 5X20 LED 24-EX
Order No. 3036821
P-FU 5X20 LED 60-EX
Order No. 3036823
P-FU 5X20 LED 60-EX
Order No. 3036836



Component connector

P-CO
Order No. 3036796

Laser marking system for challenging industrial identification

TOPMARK LASER

Robust and clear marking in the field is crucial for system operators in process technology and process engineering so that they can respond quickly and appropriately during troubleshooting, thereby minimizing system downtimes.

The TOPMARK LASER marking system meets these high requirements and marks stainless steel, aluminum, ABS, polyacrylics, and polycarbonate directly, permanently, and reliably. The integrated magazine features an automatic de-stacking and stacking function for UCT sheets, thereby facilitating fast processing of large volumes. Integration in the CLIP PROJECT planning and marking software makes the TOPMARK LASER the fastest desktop laser marker in its class.



Cable markers

LS-WMTB-V4A (29x8)
Order No. [0831516](#)

Technical data

Material	Stainless steel
Mounting type	Assembly with cable binders
Lettering field	29 x 8 mm



Device markers

LS-EMSP-V4A (39x15)
Order No. [0831653](#)

Technical data

Material	Stainless steel
Mounting type	Screws/rivets
Lettering field	39 x 15 mm

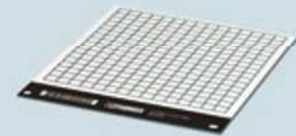

Device markers

LS-EMLP (11x9) WH
Order No. [0831678](#)

Technical data

Material	TRANSPLY-ABS
Temperature	-20°C ... +85°C
Lettering field	11 x 9 mm



Terminal markers

UCT-TM 5
Order No. [0828734](#)

Technical data

Material	PC V0
Temperature	-40°C ... +120°C
Lettering field	4.6 x 10.5 mm



Cable markers

LS-WMTB-AL (29x8)
Order No. 0831500

Aluminum
Assembly with cable binders
29 x 8 mm



Cable markers

LS-WMTB-AL (29x8) BK
Order No. 0831508

Aluminum
Assembly with cable binders
29 x 8 mm



Cable markers

LS-WMTB-V4A (D25)
Order No. 0831520

Stainless steel
Assembly with cable binders
25 mm



Cable markers

LS-WMTB-AL (D25)
Order No. 0831504

Aluminum
Assembly with cable binders
25 mm



Cable markers

LS-WMTB-AL (D25) BK
Order No. 0831512

Aluminum
Assembly with cable binders
25 mm



Device markers

LS-EMSP-AL (39x15)
Order No. 0831615

Aluminum
Screws/rivets
39 x 15 mm



Device markers

LS-EMSP-AL (50x30) RD
Order No. 0831637

Aluminum
Screws/rivets
50 x 30 mm



Device markers

LS-EMLP-AL (27x15)
Order No. 0831580

Aluminum
Adhesive
27 x 15 mm



Device markers

LS-EMLP-AL (60x30) RD
Order No. 0831649

Aluminum
Adhesive
60 x 30 mm



Device markers

LS-EMP-AL (27x15)
Order No. 0831661

Aluminum
Snap-in
27 x 15 mm

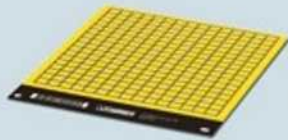

Device markers

LS-EMLP (60x30) RD-WH
Order No. 0831732

TRANSPLY-ABS
-20°C ... +85°C
60 x 30 mm



Device markers

LS-EMLP 24 (30x12) WH
Order No. 0831700

TRANSPLY-ABS
-20°C ... +85°C
30 x 12 mm



Device markers

LS-EMLP 24 (30x12) BK-WH
Order No. 0831754

TRANSPLY-ABS
-20°C ... +85°C
30 x 12 mm



Device markers

LS-EML (180x180) BK-WH
Order No. 0831784

Polyacrylate
-40°C ... +300°C
180 x 180 mm



Terminal markers

UCT-WMCO 2,9 (18x4)
Order No. 0830783

PC V0
-40°C ... +120°C
18 x 4 mm



Terminal markers

UCT-WMS 3,2 (12x4)
Order No. 0828570

PC V0
-40°C ... +120°C
12 x 4 mm

Solution concept for consistent and clear control cabinet and system marking

CLIP PROJECT planning and marking software combines the proven planning software for terminal strip configuration with a high-performance marking tool.

Direct data exchange with all common CAE programs, plus the creation of complete project documentation, are what make this configuration software unique.

CLIP PROJECT provides the ideal support for output devices and marking materials for terminal, conductor, and device marking.

This means that you can use one software tool for all printing systems for marking all applications.

Terminal marking

Conductor marking

Device/system marking



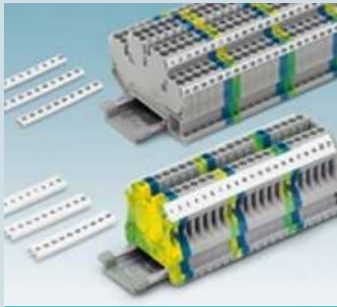

ZB/ZBF zack marker strip markers

10-section zack marker strips are available in vertical and horizontal versions. They are used to mark terminal blocks, modules or connectors and can be supplied unprinted or printed.



UC-TM UniCard markers

Markers are available in UniCard and UniSheet format for marking terminal blocks with a tall marker groove. They can be supplied unprinted or printed according to customer specifications.

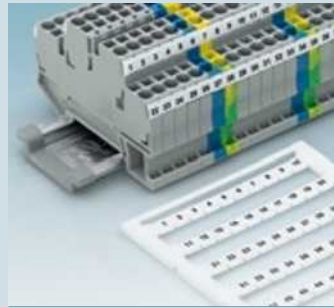

UC-TMF UniCard markers

Markers are available in UniCard and UniSheet format for terminal blocks, modules, and connectors with flat marker groove. They can be supplied unprinted or printed according to customer specifications.

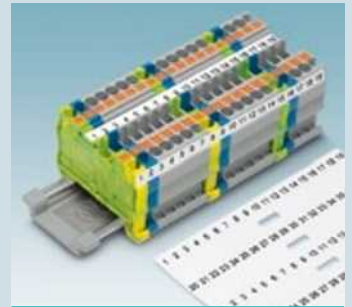

US-TM UniSheet markers

The universal marker groove can be labeled with markers in UniSheet format. They are available unprinted or printed according to customer specifications.



UC-WMC for clipping on

Clip-on conductor markers feature two marking areas, they are captive and legible at all times. They can be clipped onto pre-wired conductors and cables by hand.



UC-WMT for insertion

Conductors can be fitted with PATG and PATO marking collars. Labeling is by means of insert strips that can be marked.



UC-WMTBA for assembly with cable binders

Conductor markers can be fitted using standard cable binders almost regardless of conductor or cable diameter. The large marking area provides enough space for comprehensive marking.



WMS for threading on

Marker sleeves are perfectly suited to captive cable and conductor marking. They are available prefabricated and in rolls.



EML-HA for rough surfaces

The self-adhesive device markers have excellent adhesive properties on rough, textured, and low-energy surfaces, thanks to their special adhesive.



US-EMLSP for screwing

The UniSheet marking range includes adhesive markers which can also be attached with screws or rivets.



UCT-EM for devices from other manufacturers

The UniCard marking range includes markers for devices and switching devices from a wide range of manufacturers.



PML warning labels

The unmarked warning labels allow you to create custom warning instructions. A variety of symbols are available in the CLIP PROJECT software.

Solution concepts

Optimize all of the processes involved in the setup, installation, and maintenance of your control cabinets and switchgear. We can help you achieve this with optimally coordinated products from our tool and mounting material ranges.

The installation of switchgear and control cabinets need not be time-consuming and occupy a large amount of space if suitable mounting devices are used and the right tool is selected.

TOOLfox tools

Shielding

Cable routing and bundling



CUTFOX cutting tools

Professional cutting: cable cutters are available for processing conductors and cables up to 100 mm in diameter for all applications.



WIREFOX stripping tools

Professional stripping: the stripping tools can strip all types of conductors and cables quickly, precisely, and reliably.



CRIMPFOX crimping tools

Professional crimping: the comprehensive range of crimping pliers can be used to process all contact types up to 120 mm².



CRIMPHANDY

The Crimphandy is the smallest available hand-held stripping and crimping device. It takes just two seconds to assemble your conductors. The Crimphandy strips, fits a ferrule, and crimps in a single step.



SK shield terminals

Large-scale shielding: shield terminals are available as screw and spring versions in various sizes and provide optimum wiring convenience.

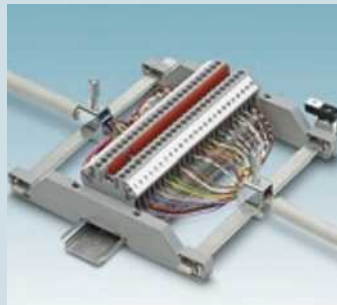

AB-SK shield support brackets

Reliable contact: the support brackets for shield terminals make contact automatically when simply clipped onto the DIN rail.



AGK connection terminal blocks

Accumulate potential: various connection, branch, and power terminals up to 35 mm² are available for busbars.



NS DIN rails

Mounting: DIN rails and busbars made from various materials and surfaces enable components to be mounted easily in a space-saving way.



CD, CD-HF cable ducts

Easy cable installation: halogen-free cable ducts in various colors enable easy and flexible cable installation, thanks to lateral segments which can be removed without tools.



WP protective hoses

Cable protection: plastic or metal protective hoses provide the right solution for any application. Screw connections with a tool-free quick mounting function in various IP protection classes round off the range.



WT cable binders

Cable bundling: for bundling cables, detectable cable binders and stainless steel or plastic cable binders are available in either a removable version or for direct mounting.



KMK cable binders with lettering field

Cable bundling and marking: the plastic cable binders can be used to mark conductors and cables as well as bundle them.

Conventional signal connection to process control systems

Phoenix Contact offers a complete range of products for signal connection to your control system.

The conventional digital and analog field signals are routed to the switch rooms via terminal boxes and multicore cables. Here, marshalling and distribution takes place using signal conditioners for intrinsically safe and non-intrinsically safe signals, e.g., with devices from the MACX or MINI Analog Pro series. In addition, field signals are sent via signal couplers, such as Safety series coupling relays, for intrinsically safe applications or over narrow 6.2 mm PLC relays to the I/O cards of the process control system.

Error-free cabling

With VARIOFACE system cabling, Phoenix Contact offers a variable cabling system as the solution for a wide range of installation concepts with standard cables or controller-specific solutions. This avoids expensive, error-prone wiring work.

Analog and digital signals must be appropriately protected against surge voltages to ensure high system availability. With our products, you will always find a suitable solution for your surge protection concept in the field or control cabinet.



Products for conventional signal connection

Universal signal conditioners MACX Analog Ex

The intrinsically safe single and two-channel signal conditioners in the MACX Analog Ex series provide a comprehensive range of functions in a width of 12.5 mm.

Highly compact signal conditioners with plug-in connection technology MINI Analog Pro

The highly compact MINI Analog Pro signal conditioners offer the easiest installation and startup in a confined space.

PLC-INTERFACE –the complete relay system

The PLC-INTERFACE relay system is the high-performance interface between the controller and system I/O devices. PLC-INTERFACE provides you with a comprehensive range of extremely narrow, plug-in relays and solid-state relays, plus a complete range of accessories.

SIL-certified PSR safety relays

The safety relays certified up to SIL3 provide solutions from emergency stop monitoring to coupling failsafe controllers. This means that both ESD and F&G applications can be implemented in accordance with IEC 61508 and IEC 61511.

Surge protection

In order to ensure high system availability, the process control system must be protected. The consistent use of surge protection modules for all input and output signals provides an optimum protective function.

Standard termination boards and cables

VARIOFACE wiring interface offers a wide and varied range of standardized interface modules for connecting single wires at sensor and actuator level to the controller in industrial applications.

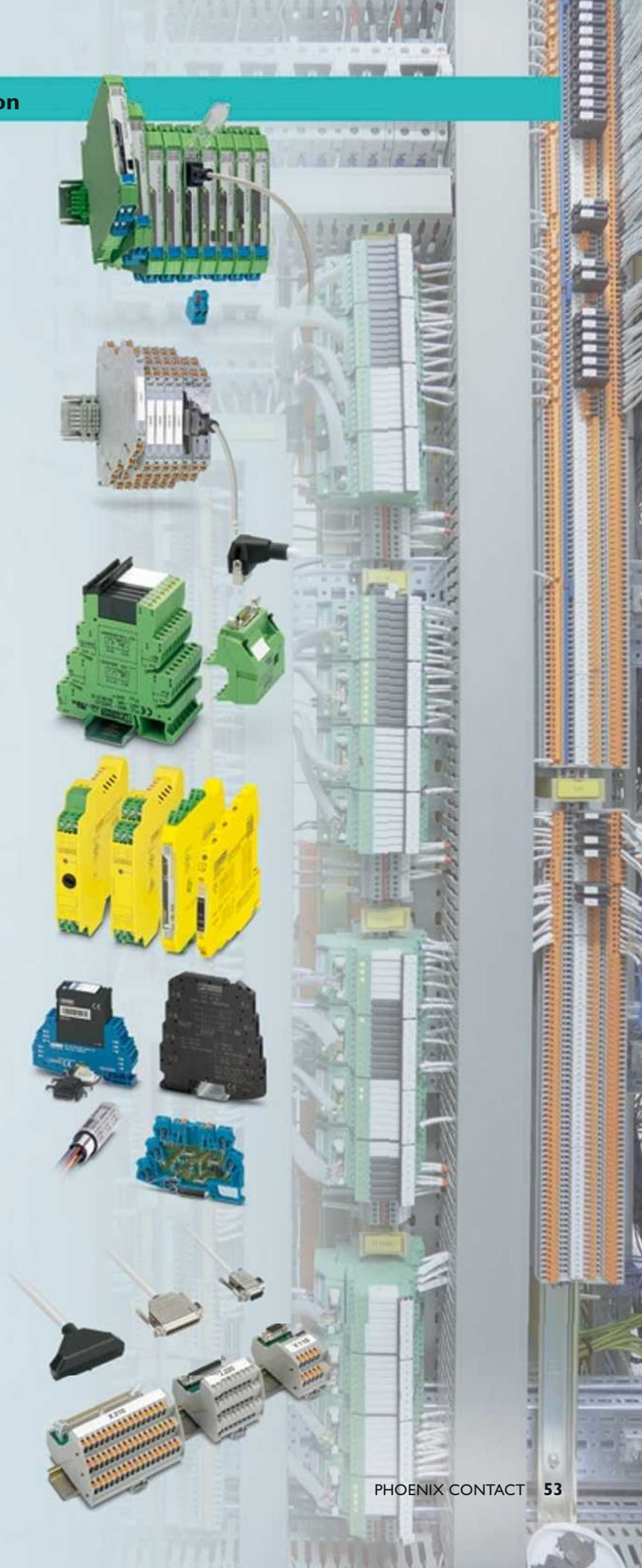

MACX Analog Ex

Highly compact and leading technology

With an overall width of just 12.5 mm, MACX Analog Ex offers a wide range of single and two-channel signal isolators for intrinsically safe circuits in the ex area. The products are type-tested by an independent NAMUR test laboratory in accordance with NE 95 and therefore satisfy the high requirements of the chemical industry.

Suitable for all Ex zones and gas groups

All MACX Analog Ex isolators are approved in accordance with the applicable ATEX and IECEx standards:

- **Ex i** – for intrinsically safe circuits up to Ex Zone 0 (gas) and Ex Zone 20 (dust)
- **Ex n** – for installing devices in Ex Zone 2

Relevant national approvals such as UL and GOST are available.



HART communication

Bidirectional transmission of the HART communication signal for all Analog IN and Analog OUT isolators.

Hot-swappable module replacement

Easy system expansion or module replacement during operation.

Fast diagnostics

LED displays in accordance with NE 44 for supply voltage, switching state, and faults.

Easy-maintenance connection terminal blocks

Plug-in, coded connection terminal blocks with integrated test sockets.

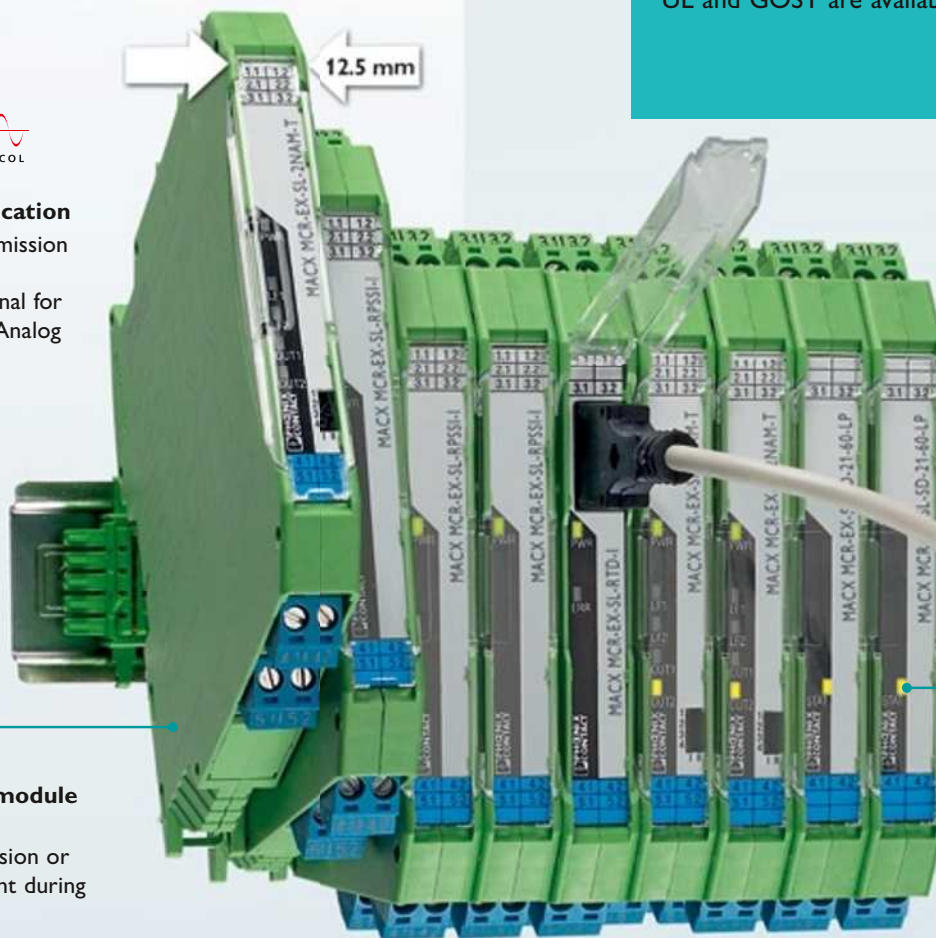

Your advantages



The end-to-end SIL-capability of the devices provides the highest degree of system safety and availability.



Bidirectional transmission of the HART communication signal for all Analog IN and Analog OUT isolators.



Safe electrical isolation protects personnel and the system.



Long service life and precise transmission, thanks to a patented circuit with low current consumption.



Versions with two-channel design (MACX MCR-...-2...).



LED display in accordance with NAMUR NE 44 for supply voltage, switching state, and faults.



The DIN rail connector enables the modular bridging of the 24 V supply voltage.



Versions with wide range power supply for global power supply networks (MACX MCR-EX-...-UP).

Push-in Technology

Designed by PHOENIX CONTACT

Power supply and diagnostics – flexible and easy with the DIN rail connector

Easily bridge the 24 V supply voltage using the modular DIN rail connector. This simplifies wiring and enables system expansion or module replacement even during operation.

The DIN rail connector offers two supply options:

1. Direct supply

Via any MACX Analog Ex module

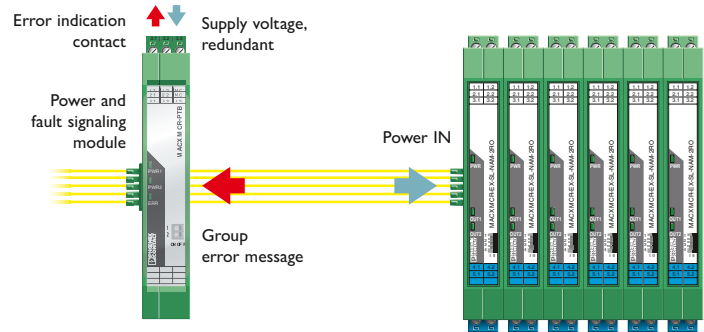

2. Via the power and fault signaling module

- Simple or redundant supply (decoupled from diode)
- Error message output (message in the event of auxiliary voltage failure and line fault group message in the case of NAMUR signal conditioners)

Maximum explosion protection with minimum space requirements

With a housing width of just 12.5 mm for all single and two-channel 24 V devices, MACX Analog Ex offers space savings of up to 45% compared to other Ex i signal conditioners on the market.

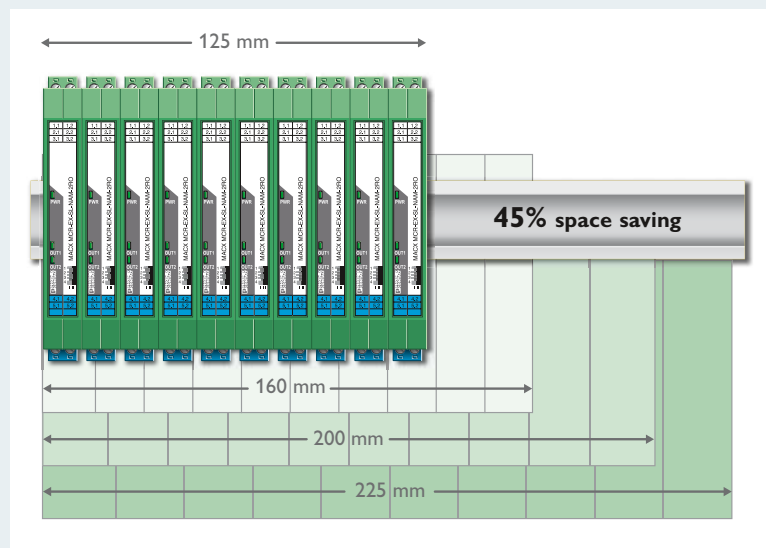

MINI Analog Pro

Easier than ever but as slim as before

The highly compact MINI Analog Pro signal conditioners offer the easiest installation and startup in a confined space.

Thanks to the design, all connection and operating elements are easily visible.

Push-in Technology

Designed by PHOENIX CONTACT

Choice of connection technology

Wiring with screw connection or fast and tool-free push-in technology.

Easy maintenance

Large-surface marking areas for complete loop identification using standard marking material.

Easy installation

Easily visible and accessible terminal points and FASTCON Pro plug-in connection terminal blocks.

6.2 mm

Consistent diagnostics

Status LEDs in every signal conditioner are always visible and clearly labeled.

Rapid power bridging and error indication

The devices can be easily connected via the modular DIN rail connector: en-Busverbinder.

Measure current signals easily

Measure current signals during operation without disconnecting the current loop.

Your advantages

- Easy installation, thanks to easily accessible terminal points and plug-in connection terminal blocks
- Measure current signals during operation without disconnecting the current loop and optional disconnect function
- Numerous parameterization options by means of DIP switch configuration, software or a smartphone app
- Easy to maintain, thanks to large-surface marking areas, status and error indicators, and group error messaging
- Wiring with screw or push-in connection

Main features

- Front operation
- State-of-the-art switching technology
- Safe electrical isolation with 3 kV test voltage
- Supply voltage range: 9.6 V DC ... 30 V DC
- Temperature range: -40°C ... +70°C
- Multifunctional device types

Universal use

Thanks to the intern. approval package



- **Ex n** – for installing devices in Ex Zone 2

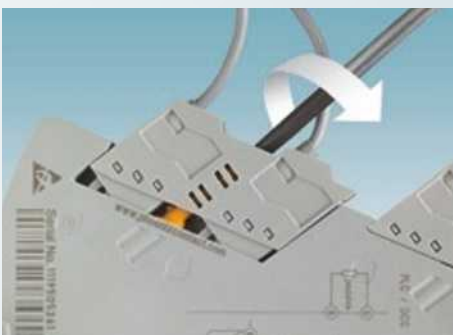

Easy startup and maintenance

Interrupt signal and supply circuits with just a twist of the wrist with the integrated disconnect function.



Numerous parameterization options

Easy configuration via DIP switches as well as extended configuration via software or smartphone app without additional accessories.



Optimum signal quality

State-of-the-art switching technology with multifunctional device types, safe electrical isolation, and extended supply voltage and operating temperature range.

MINI Analog

Highly compact and leading technology

Measuring temperatures, converting, isolating, and filtering signals – with MINI Analog you can transmit your analog signals reliably and without distortion.

MINI Analog provides maximum efficiency in terms of space, costs, power consumption, planning, installation, and configuration.

Time-saving system cabling

Plug and Play for eight channels on the signal conditioner and controller side.

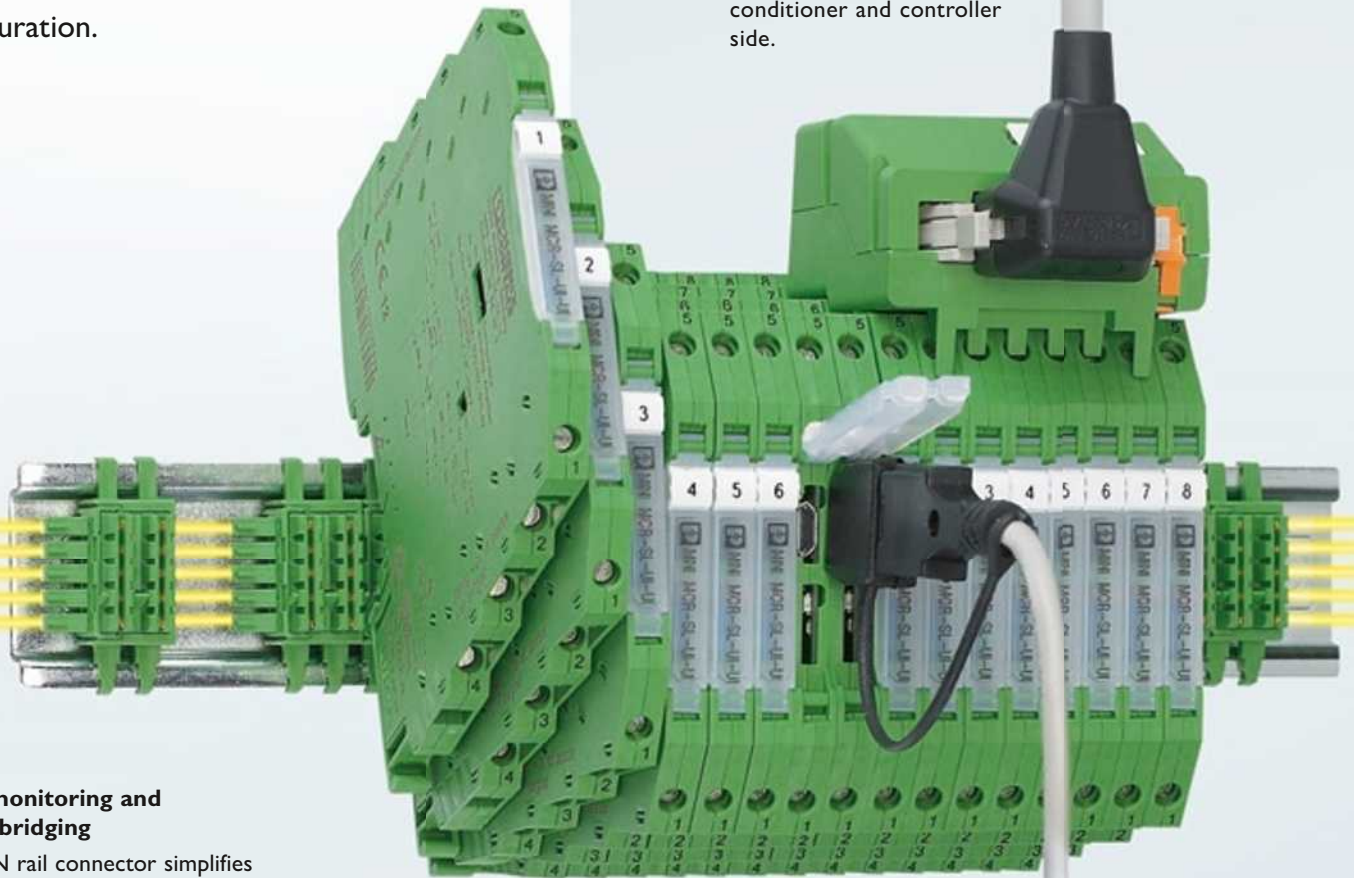

Fault monitoring and power bridging

The DIN rail connector simplifies supply and enables convenient group error monitoring.

Significant space savings

Space savings of up to 65% compared to other signal conditioners on the market, thanks to an overall width of 6.2 mm.

Your advantages



Easy configuration via DIP switches, no software, cables or notebook required.



Consistent electrical isolation between input, output, and supply.



Long service life, thanks to the innovative circuit design with low current consumption.



Choice of screw or spring-cage connection technology.



Installation in Ex Zone 2.



The DIN rail connector enables the modular bridging of the 24 V supply voltage.



Easy installation

The system cabling enables error-free wiring of eight analog channels on both the isolator and controller side, with time savings of up to 95% – all thanks to Plug and Play.

- **Ex n** – for installing devices in Ex Zone 2.



The Termination Carrier for MINI Analog is the perfect solution for quick and error-free connection to the control system.

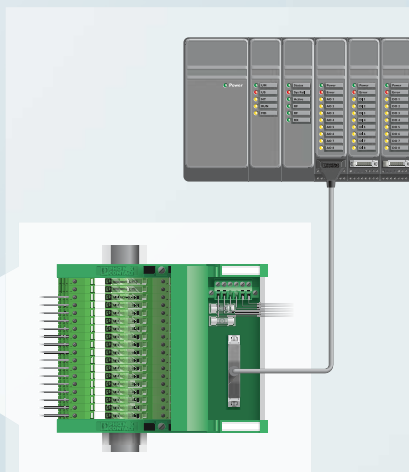
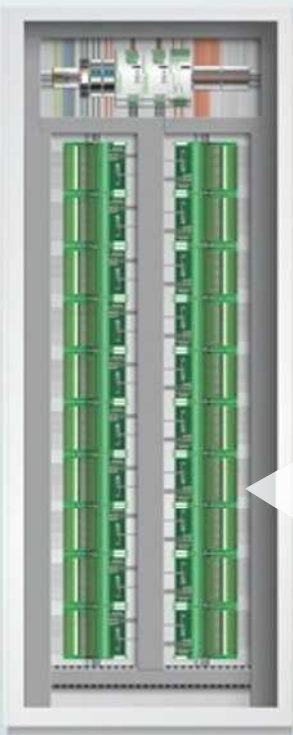

When used in combination with MINI Analog, the Termination Carrier offers unrivaled packing density: install up to 320 channels in an 80 x 200 cm control cabinet. Phoenix Contact offers a comprehensive portfolio of system cables for specific control systems.

In addition to universal Termination Carriers, versions tailored to your control system are also available.

Please contact us for more information.

RIFLINE complete

The relay system with universal plug-in design

You can implement all of your standard relay applications using the RIFLINE complete industrial relay system. Whether you want to isolate, multiply or amplify signals, it makes no difference.

The relay system with universal plug-in design supports high machine and system availability. The field of application ranges from coupling and time relays to a replacement for small power contactors.

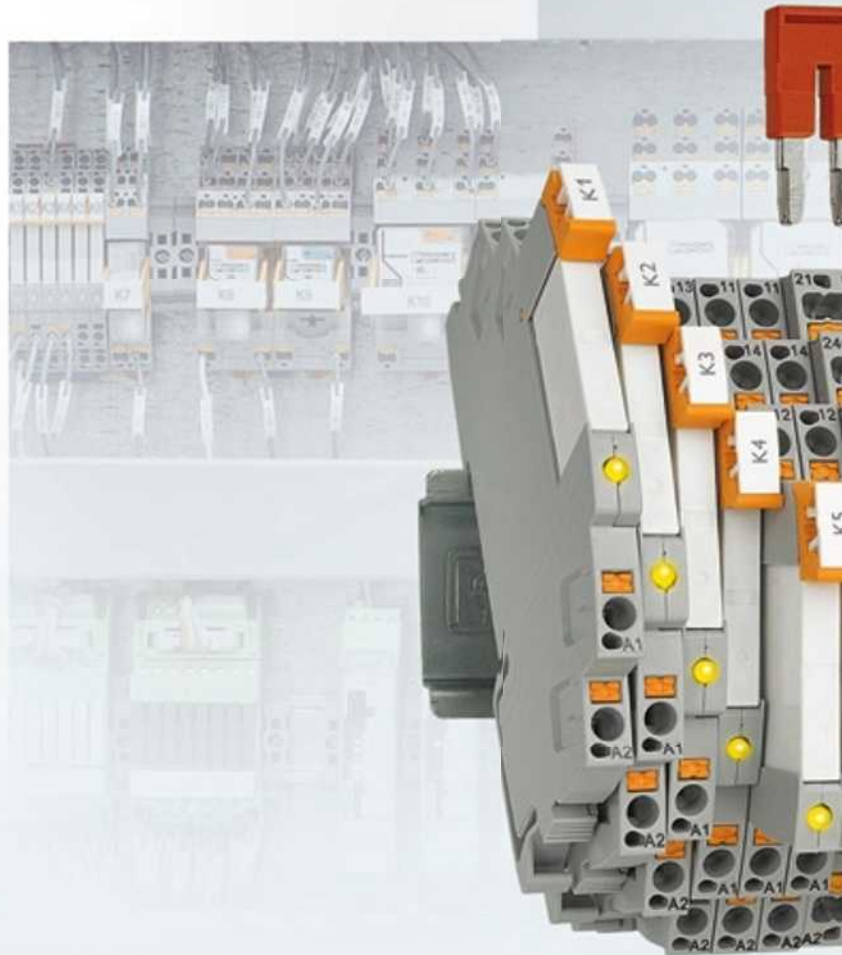

Easy handling in detail



Easy wiring

Thanks to push-in connection technology. This enables quick, tool-free wiring.



Easy potential distribution

With jumpers from the CLIPLINE complete system accessories.



Easy extension

With the plug-in, multifunctional timer module.

Three time functions can be selected in a time range from 0.5 seconds to 100 minutes.



Push-in technology

Use proven push-in connection technology with RIFLINE complete. This enables quick, tool-free wiring. The release button to release the conductor can be actuated using a screwdriver or even a ballpoint pen.



Push-in Technology

Designed by PHOENIX CONTACT

High availability thanks to plug-in relays and function modules

The relays can be replaced quickly during maintenance work. This therefore ensures high machine and system availability.

Complete relay range

Switch currents up to 16 A. From coupling relays to a replacement for small power contactors, the product range offers the right relay for every application.

PLC-INTERFACE

The complete relay system

The PLC-INTERFACE relay system from Phoenix Contact is the high-performance interface between the controller and system I/O devices.

PLC-INTERFACE provides you with a comprehensive range of extremely narrow, plug-in relays and solid-state relays, plus a complete range of accessories.

In addition, PLC sensor/actuator versions, switch modules, and filter series always provide the right solution for special applications.

PLC-INTERFACE plus system cabling – fast plug-in connection of the controller and I/O devices.

PLC-INTERFACE for Zone 2

Selected relay types can be installed in Zone 2. These types are documented under “Solutions for digital output signal processing” on page 90.

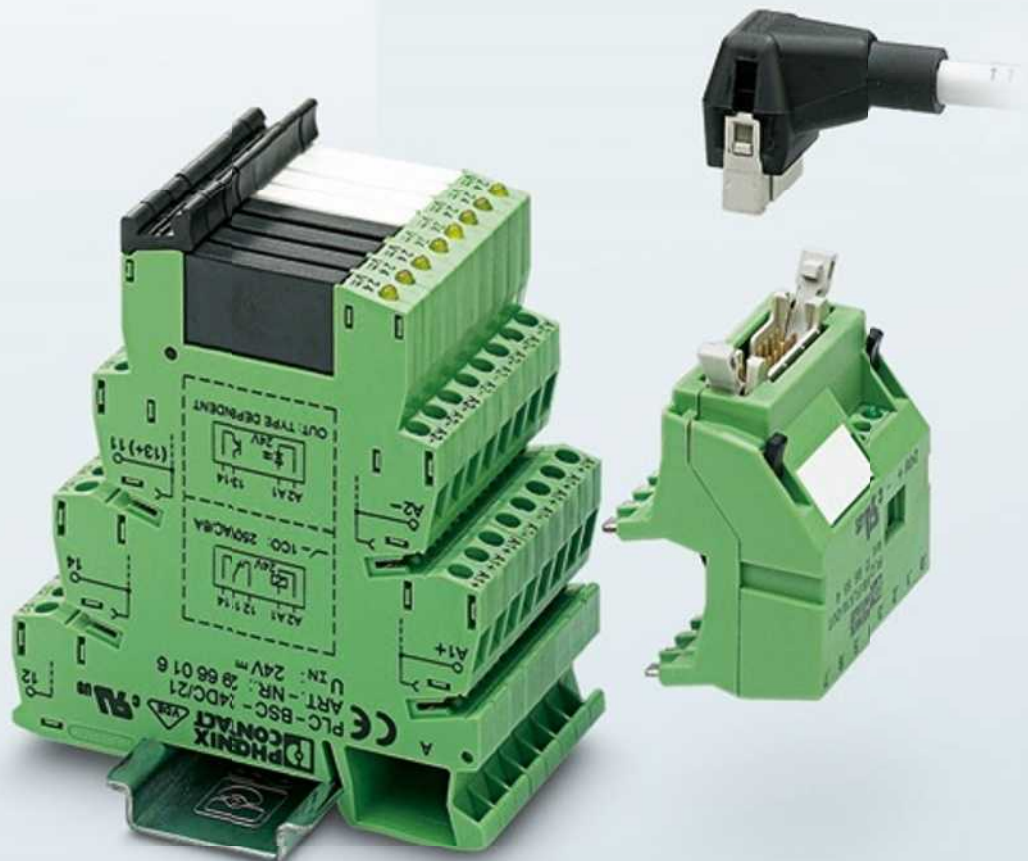

Your advantages

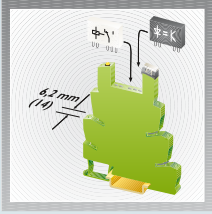

PLC-INTERFACE

- The interface between the automation device and system I/O devices with a high switching capacity
- Available as plug-in relay interface or solid-state relay interface
- Interface technology with all the advantages of proven terminal block technology

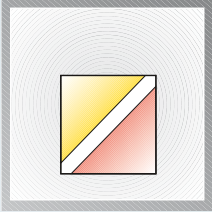

PLC-INTERFACE provides safety

- Protection against environmental influences, thanks to RT III (IP67)-protected relays and solid-state relays
- Relays with safe isolation in accordance with DIN EN 50178 (VDE 0160)
- High-quality and reliable Phoenix Contact connection technology, with screw, spring-cage or push-in connection.



PLC-INTERFACE saves:

- Wiring effort, thanks to the convenient pitch-free jumper system
- Space on the DIN rail, thereby freeing up more of the control cabinet
- Storage costs and ordering costs, thanks to universal, plug-in PDT relays
- Material costs as a result of inexpensive components
- Power and return conductor terminal blocks for sensor and actuator wiring

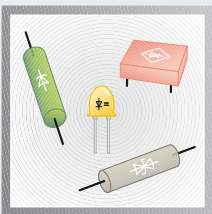

PLC-INTERFACE simplifies:

- Installation, thanks to the integrated input and protective circuit
- Identification by using standard marking material
- Potential connections by allowing you to bridge all important potentials

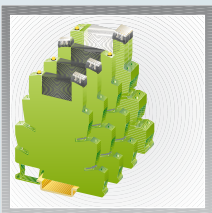

PLC-INTERFACE provides convenience and service

- Actuator and sensor versions that can accommodate all sensor and actuator connections directly at the interface
- Easy replacement of relays or solid-state relays without disconnecting the wiring
- LED status indicator per channel

PSRmini

Reliable signal availability in the process industry

As a specialist in the process industry, you rank compatibility and reliability among the primary requirements for your systems and components.

For this reason, we would like to introduce to you our highly compact, safe coupling relay for electrical isolation and power adaptation.

Adapted to the relevant process control systems and special requirements of your industry, we offer SIL-certified coupling modules for emergency shutdown and fire and gas applications.

Force-guided contacts

A safety relay for monitoring functions in machines and systems is based on relay technology with force-guided contacts according to EN 50205.

In a safety switching device with integrated monitoring, forced guidance is used for safety detection. Dangerous errors, such as the welding of contacts, are therefore reliably detected and a high level of safety is achieved.

Highly compatible

Compatibility with the various safety-related systems enables a large usage range.



Comprehensive approvals

Thanks to a variety of worldwide approvals, PSRmini is available in all relevant markets. For the first time, the installation of safe coupling relays up to Ex Zone 2 is possible.

Convenient connection methods

Screw and push-in spring-cage connection technology offers convenient control cabinet installation.



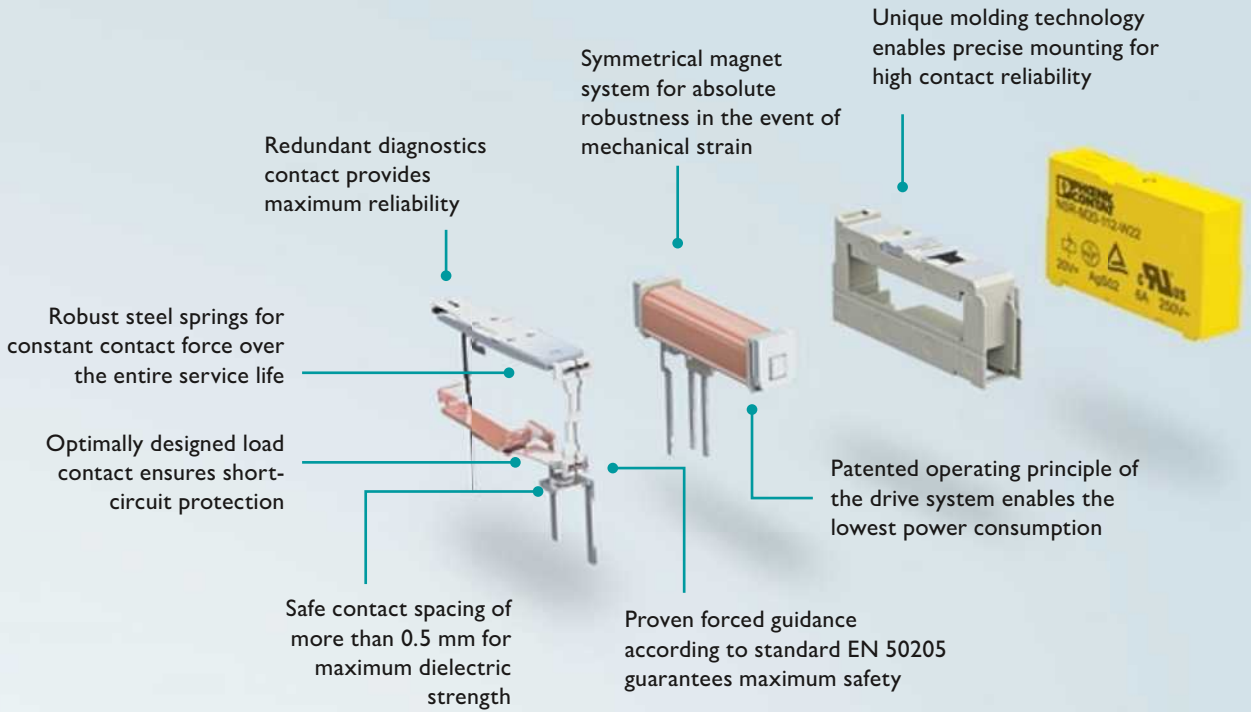

Highly compact in 6 mm and 12 mm

The narrowest safety relay with force-guided contacts offers space savings of up to 70%.

Active error acknowledgment

Errors can be reported back to the higher-level safe system via the signal control.

Available for one or more contacts

Fine-grained architecture enables the modular design of safety concepts: the 6 mm version comes with one enable path, the 12 mm version with two.

Relay Technology

Designed by PHOENIX CONTACT

Innovative relay technology from Phoenix Contact offers maximum safety and high switching loads up to 6 A.



PSRmini

Highly compact safety and coupling relays

Phoenix Contact has been a partner of the process industry for many years. The new, safe PSRmini coupling relays are the result of this close cooperation and boast unique product features:

- Minimal space requirements and high scalability
- Easy diagnostics directly on the device and controller thanks to forced guidance
- Comprehensive approval package and extended temperature range across the entire device series
- Customer-specific Termination Carriers with system cabling

Your benefits

We strive to contribute to the safety of your system and to minimize downtimes. We also reduce space and material requirements. For you, this means:

- Fewer control cabinets required, as up to 70% less space is required
- Shorter downtimes during scheduled maintenance phases, thanks to quick and easy diagnostics
- The safe coupling relays can be used up to potentially explosive areas, thereby simplifying the design of distributed concepts for the first time
- Shorter installation times and quick and easy startup



When used in combination with PSRmini, the Termination Carrier offers unrivaled packing density in the control cabinet.

PSR-PC50

Safe switch on guaranteed



Both safety-related circuit interrupts and safe switch on are becoming increasingly important. A SIL-certified coupling module has been developed specifically for this requirement.

Special attention was given in particular to end-to-end diagnostics so as to ensure optimum integration in the safety loop. The line/load monitoring function of the PSR-PC50 enables consistent diagnostics from the controller to the actuator. A potential open circuit, short circuit or missing load is indicated via the wiring between the digital output and the coupling module. This eliminates the need for additional installation time and other digital inputs required for actuator readback. This type of active error acknowledgment is also integrated in the ESD modules in the PSRmini range.

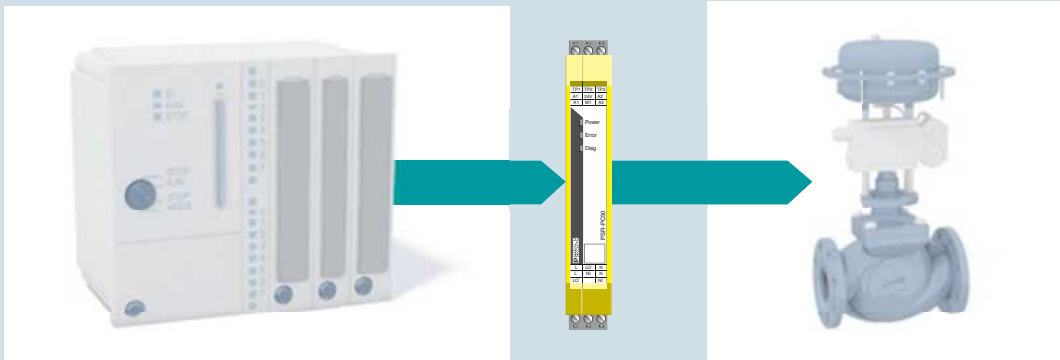

Safe switch on with end-to-end diagnostics from the controller to the actuator

PSRclassic

Compatible coupling relays with force-guided contacts

Designed specifically for the process industry, the PSRclassic range offers coupling relays with force-guided contacts for safe switch on and shutdown.

SIL-certified coupling relays are available for safe signal processing for a large number of functions that are required for emergency shutdown or fire and gas applications, for example.

Compatible with a range of different safe systems

The integrated test pulse filter and the adapted current control circuit ensure a long service life and optimum compatibility with common safe systems from well-known manufacturers in the process industry.



Approvals and characteristics

All certificates and characteristics are available for easy loop calculation, configuration, and document creation. SIL certification can be identified by the yellow housing color.



Easy diagnostics

Features and functions such as force-guided safety relays and line and load detection ensure optimum diagnostics and availability.

PSRclassic in the Termination Carrier

As with PSRmini, the prewired Termination Carriers from Phoenix Contact enable fast, error-free mounting and connection to common safe systems.

Signal connection is by means of Plug and Play using standardized system cables. Standardized or controller-specific front adapters are used for connection to your safe system.



Coupling relays with forced guidance

The use of coupling modules with force-guided contacts is recommended wherever safe diagnostics is required.

PSRmini and PSRclassic

Product overview



Selection matrix for applications

If you need one device with one function, PSR safety switching devices are the perfect solution. Our devices operate with force-guided contacts according to EN 50205.

You will find the corresponding coupling relay for your application in the tables below.





PSRmini – highly compact safe coupling relays for the process industry



Type	Applications	Output contacts		Diagnostics/proof test				Safety approvals					Overall width	Connection method	
				Visual via LED	Active error acknowledgment via A1	Measurement on the device	Self-monitoring with integrated lock	SIL IEC 61508/61511	SIL IEC 50156	ATEX / IECEx / Class I Zone 2	G3 ANSI / ISA-S71.04	GL		Screw, plug-in	Push-in spring-cage, plug-in
PSR-PS20	Highly compact, safe coupling relays for failsafe controllers... ... for safety-related shutdown (ESD)	1	1 NC / 1 DO	X	X	X	-	3	3	X	X	X	6.8 mm	2700356	-
PSR-PS21		1	1 NC / 1 DO	X	X	X	-	2	2	X	X	X	6.8 mm	2700357	-
PSR-PS40		1	1 DO	X	-	-	X	3	3	X	X	X	6.8 mm	2700398	-
PSR-PC20		1	1 NC / 1 DO	X	X	X	-	3	3	X	X	X	12.5 mm	2700577	2700578
PSR-PC40		2	1 DO	X	X	-	X	3	3	X	X	X	12.5 mm	2700588	2700589
PSR-PC50	...for safety-related switch on (F&G)	1	1 DO	-	X	X	-	3 ¹⁾	-	X	-	X	17.5 mm	2904664	2904665

¹⁾ Low demand, NC = N/C contact, DO = Digital signal output
Customer-specific Termination Carriers are available on request

PSRclassic – coupling relays with forced guidance for universal use

Type	Applications	Output contacts			Connection method				Input voltage	Order No.
					Screw, plug-in	Spring-cage, plug-in	Screw, fixed	Spring-cage, fixed		
PSR-URM	Coupling relays for universal applications	5	2	-	X	-	-	-	24 V UC	2963747
					X	-	-	-	120 V UC	2981402
					-	X	-	-	24 V UC	2963970
					-	X	-	-	120 V UC	2981415
PSR-URM/3X1		3	3	-	X	-	-	-	24 V UC	2981839
					-	X	-	-	24 V UC	2981842
PSR-URM/5X1		5	1	-	X	-	-	-	24 V UC	2981952
					-	X	-	-	24 V UC	2981965
PSR-URM/2X21		-	-	2	-	-	X	-	24 V UC	2981363
					-	-	X	-	120 V UC	2981376
PSR-URM/4X1		4	2	-	-	-	X	-	24 V UC	2981444
					-	-	X	-	120 V UC	2981460
	-				-	-	X	24 V UC	2981457	
	-				-	-	X	120 V UC	2981473	

PSRclassic – conventional safe coupling relays for the process industry

Type Input voltage	Applications	Output contacts			Safety approvals			Connection method		Order No.
					SIL IEC 61508	SIL IEC 61511	SIL IEC 50156	Screw, plug-in	Spring-cage, plug-in	
PSR-FSP 24 V DC	Coupling relays for failsafe controllers	1	1	-	3	3	3	X	-	2981978
								-	X	2981981
PSR-FSP/2x1 24 V DC		2	1	-	3	3	3	X	-	2986960
								-	X	2986957
PSR-FSP2/2x1 24 V DC		2	1	-	2	2	2	X	-	2986575
								-	X	2986588
PSR-ETP 24 V DC		1	-	-	3*	3*	-	X	-	2986711
	-							X	2986562	
PSR-ESP4 24 V DC	2	1	-	3	3	-	X	-	2981020	
							-	X	2981017	

*Low demand

PSRclassic – accessories

TC-DO16-ESD	Termination Carrier for ESD applications	2902913
TC-C-PSR3-M	Cable set if confirmation contact is used	2903390
TC-C-PSR3	Cable set if confirmation contact is not used	2903389
TC-C-PTSM-J	Bridge plug for occupying unused module slots	2903388
TC-DO16-F&G	Termination Carrier for F&G applications	2902914
TC-C-PSR3-24V	Cable set with 24 V module supply	2903391

Inline Ex i

Intrinsically safe I/Os for the ex area

The intrinsically safe I/Os connect input and output signals to your network or bus system.

A selection of standard I/O terminals for use in potentially explosive and non-potentially explosive areas up to Zone 2 is available. Additional input and output signals from potentially explosive areas of Zones 1 and 0 can be connected to the blue I/O modules. To do this, simply mount the modules on the Inline station. Parameterize the terminals with FDT technology and use channel-specific diagnostics for troubleshooting.



Ex i analog input/output

Thanks to two current ranges (0/4 to 20 mA) for input and output, as well as an input voltage range of 0 to 10 V, this 4-channel module can be used universally.



Ex i power supply

The power supply indicates the current status via several control displays. The supply terminal can distinguish between the different states: voltage present, high load range, and overload.

The terminal is electronically protected against overload and is very energy efficient.

Ex i temperature input

The 4-channel temperature input module supports standard thermocouple sensors and commercially available resistive temperature measuring devices. The shield connection integrated on the terminal enables easy wiring and provides protection against electromagnetic interference.

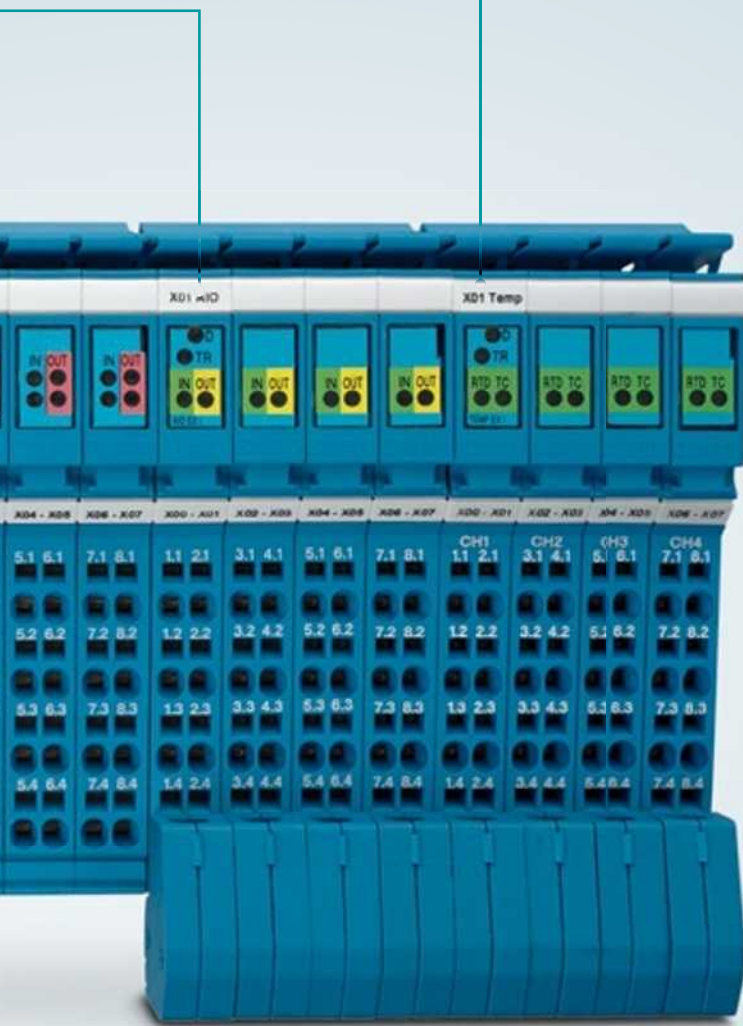

Ex i analog input/output

The 4-channel digital I/O module supports inputs for NAMUR initiators and mechanical contacts, outputs for intrinsically safe solenoid valves, acoustic alarm indicators, and signal lamps.



Operation and installation of I/Os in Ex zones

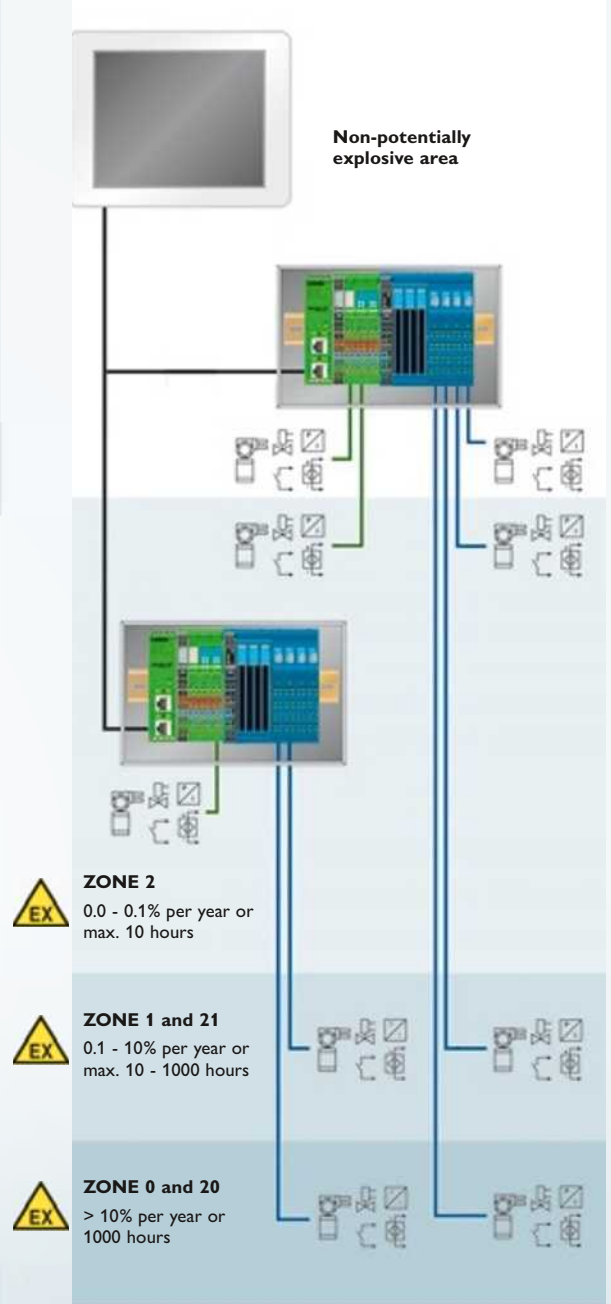

Device circuit breakers

Overcurrents firmly under control

Device circuit breakers offer reliable protection in the event of overload and short-circuit currents. The circuit breakers ensure high system availability by selectively switching off the faulty circuit.

Push-in Technology

Designed by PHOENIX CONTACT



The complete product portfolio:

CB modular device circuit breaker, CBB device circuit breaker board, and
CBM multi-channel electronic device circuit breaker

Thanks to active current limitation, the modular electronic device circuit breakers prevent interruption of the output voltage. The thermomagnetic circuit breakers with SFB technology offer maximum overcurrent protection for long cable paths. The installation can be extended very easily, customized, and branched over a wide area.

Central potential distribution can be implemented optimally with the multi-channel device circuit breaker boards. Installation time is reduced to a minimum. The boards are very versatile as they can be fitted individually with thermomagnetic and electronic circuit breakers.

Thanks to dynamic current limitation, the multi-channel electronic device circuit breakers prevent interruption of the output voltage in the event of an error. The individual adjustability of the 4 and 8-channel devices provides a convenient and space-saving solution for every application.



Surge protection

The protective circuit principle

The protective circuit principle defines complete protection against surge voltages. An imaginary circle is drawn around the devices, plants or systems to be protected.

Surge protective devices that correspond to the nominal data of the relevant power supply or signal type should be installed at all points where cables intersect this circle. In order to provide objects with consistent protection against conducted surge voltage couplings, the following areas should be taken into consideration:

- Power supply
- MCR technology
- Information technology
- Transceiver technology

■ Power supply

Optimally coordinated arresters for supplies, distributors, and end devices safeguard the energy supply.

■ MCR technology

Optimized arresters are available for a wide range of signal types and measuring principles.

■ Information technology

High-speed protection (CAT6+) for data and communication technology.

■ Transceiver technology

So that private mobile radio and mobile communication, as well as satellite or radio systems, still have reception whatever the weather.



Surge protection components ensure high system availability

Surge protection for the power supply

The comprehensive product range includes the Safe Energy Control family, which features type 1, type 2, and type 3 protective devices for all applications. Powerful, impact-free, and in a compact design, they provide ideal protection for every system.



Safe Energy Control Technology

Designed by PHOENIX CONTACT

Surge protection for measurement and control technology

Surge protective devices for MCR technology protect particularly sensitive signal interfaces in your system. The comprehensive product range includes protective devices for all common signals and the ex area.



Surge protection for information technology

Fast protection for fast signals. Sensitive devices, such as those used in information technology, require protection that is optimally coordinated. The powerful protective devices, which respond quickly, provide safety for all common applications.



Surge protection for transceiver systems

Interference-free signal transmission is extremely important for wireless networks. The surge protective devices with low insertion loss provide optimum protection for communication and the associated infrastructure in the system.

Intelligent surge protection

Protect your signal interfaces with PLUGTRAB PT-IQ intelligent surge protection.

This microprocessor-controlled monitoring system indicates any wear of protective devices before an overload can result in their failure. This means that you are always kept informed of the state of arresters – whether directly on site or by means of user-friendly remote signaling. This enables you to schedule servicing and increase system availability.



Push-in Technology

Designed by PHOENIX CONTACT

The surge protection system in detail

DIN rail bus

- Reduces wiring effort significantly
- Transmits the status of arresters to the controller

Controller

- Supplies power to up to 28 protective devices
- Signals the status of protective devices, also via remote signaling

Connection

Choose between screw connection or push-in connection technology.

Protective devices

- Integrated microprocessor for status monitoring
- Status indicator on each individual module

Self-latching protective plug

The plugs can be easily replaced during operation – impedance-neutral insertion and removal is what makes this possible.



Surge protection for the field device

The robust SURGETRAB solution is specifically designed for easy installation on transducers in the field. Effective protection can therefore be provided for all common transmission methods and fieldbus signals. Use in ex areas is also possible.

Predictive monitoring:



OK



Performance limit reached, replacement recommended



Overloaded, replacement required

Isolating spark gap

Lightning protection equipotential bonding for pipelines

The FLT isolating spark gap protects the sensitive insulating flanges and the coating of a pipeline against damage caused by surge voltages. Voltage peaks which are caused by lightning strikes can damage or even destroy the insulation of flanges. The isolating spark gap limits surge voltages to the extent that no damage is caused to the insulation. Cost-intensive failure times and possible environmental pollution from leakages are avoided from the outset. The isolating spark gap is approved for use in potentially explosive areas.

Your advantages at a glance:

- High discharge capacity of 100 kA
- Maximum category H in accordance with IEC 62561-3
- Low response voltage ≤ 1250 V (1.2/50 μ s)
- Rated power-frequency withstand voltage of 250 V AC
- Suitable for use in harsh ambient conditions
- For installation in Ex Zone 1 and 2 (ATEX, IECEx)



Accessories

Comprehensive range of accessories for connecting the isolating spark gap in a horizontal or vertical position. Terminal boards and brackets with hole diameters from 11 mm to 62 mm are available for installation in a variety of applications. Pre-assembled connecting cables are available in three lengths.



Reliable connection of pipeline segments: insulating flange with isolating spark gap



The isolating spark gap protects against damage to insulating flanges which are vital for the segmentation of the pipeline. In the event of a surge voltage, the isolating spark gap becomes low resistant and bypasses the insulation between the individual pipeline segments. The isolating spark gap discharges the surge voltage to ground at defined pipeline sections.



The FLT isolating spark gap is characterized by its high discharge capacity and very low response voltage. The product and accessories have been optimized for use with the most popular insulating kits for pipeline flanges.



Consideration should be given to surge protection and equipotential bonding as early as the planning stage. In pipeline construction, pipes are assembled in segments and electrically isolated from one another in order to provide effective cathodic corrosion protection. Insulating flanges act as connecting elements between the individual pipe segments. It is important to provide indirect equipotential bonding here.

Protection concept for a process system

In order to create an effective protection concept, it is important to know where devices that are in danger are located and what influences represent a danger to them. A distinction must be made between danger from direct lightning strike and indirect surge voltages.

The system to be protected is divided into lightning protection zones (LPZs). The appropriate lightning and surge protective devices must be installed at the zone transitions.

Lightning protection zones

- LPZ 0A (direct lightning strike): danger zone outside the building
- LPZ 0B (direct lightning strike): protected danger zone outside the building
- LPZ 1: zone inside the building where high-energy surge voltages represent a danger
- LPZ 2...n: zone inside the building where low-energy surge voltages represent a danger

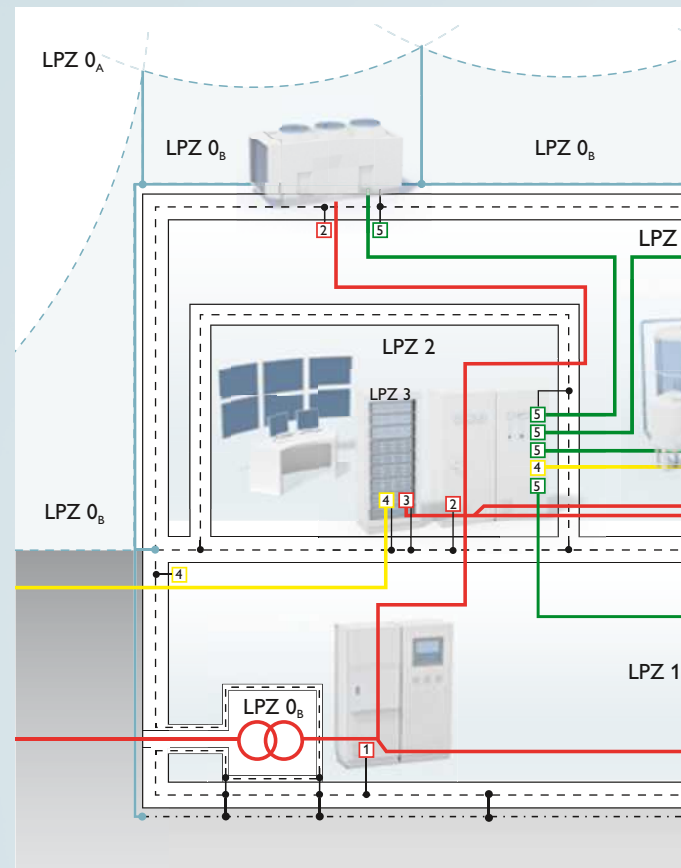
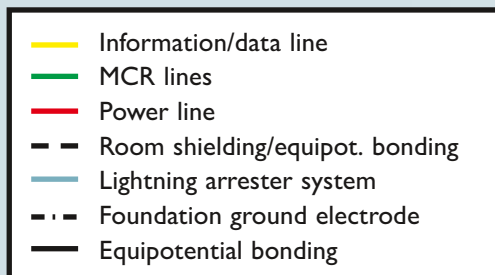

Power supply

1



2



3



Information and data technology

4



4



MCR technology

5



5



Lightning protection equipotential bonding

6

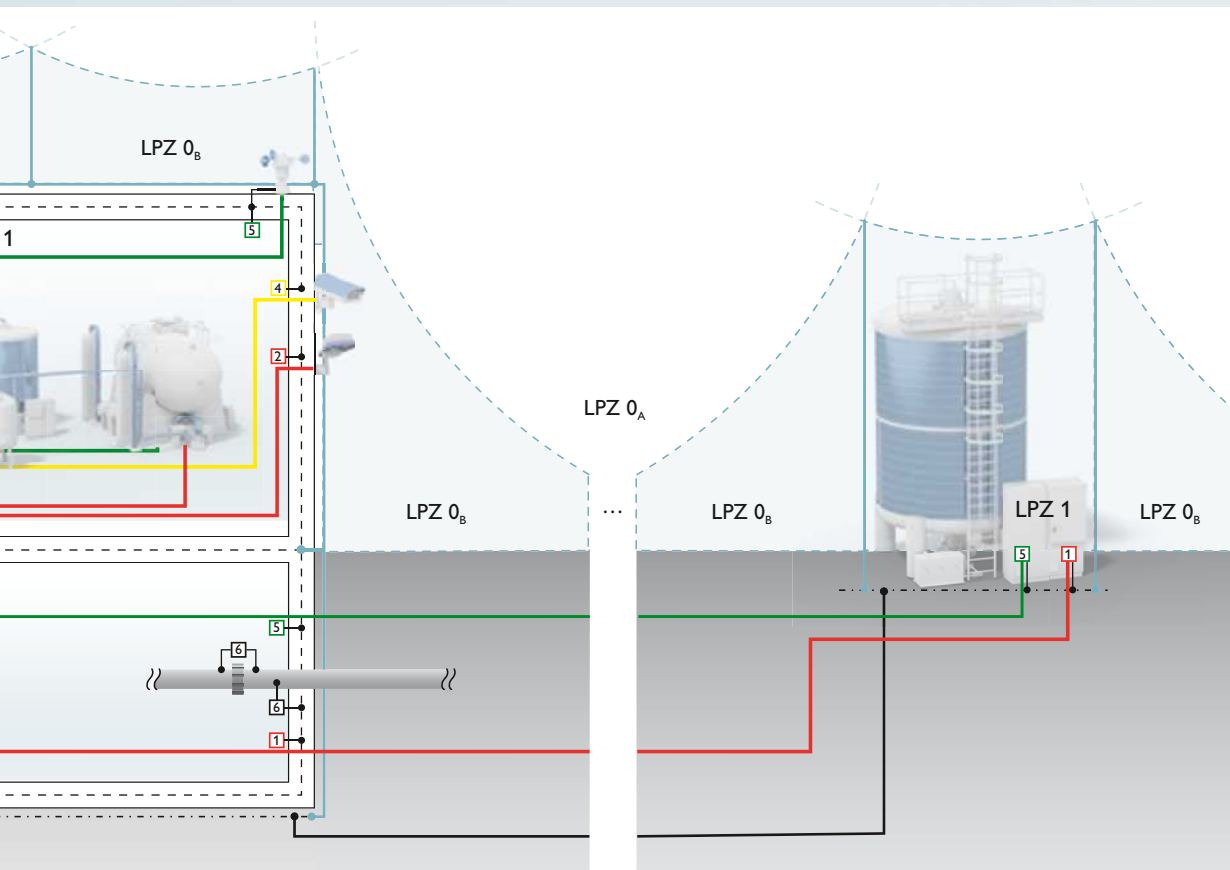

Solutions for analog input signal processing

Comprehensive solutions are available for connecting analog input signals from the field level to process control systems. They include measuring transducers, signal conditioners, and repeater power supplies, such as the Inline I/O remote control system.

Suitable surge protection and system cabling solutions complete the turn-key solution.

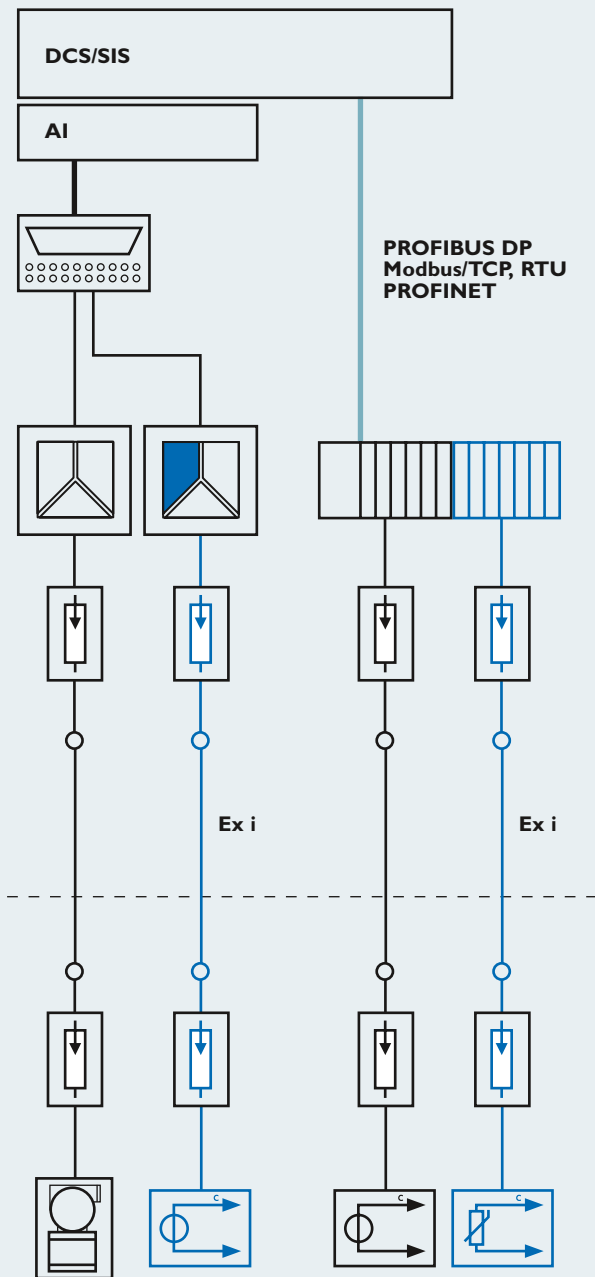

3-way sign. conditioner/ repeater power supply

MACX MCR-UI-UI-NC
Order No. [2811446](#)

MACX MCR-UI-UI-UP-NC
Order No. [2811297](#)

MACX MCR-SL-RPSSI-I
Order No. [2865955](#)

MACX MCR-SL-RPSSI-2I
Order No. [2924825](#)

For more devices, visit our website

Approvals

ATEX, IECEx, UL, SIL, etc.

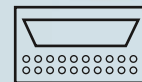

Uni system cabling

VIP-2/SC/FLK10
Order No. [2315010](#)

FLK 10/EZ-DR/ 50/KONFEK
Order No. [2299204](#)

You can choose surge protection modules according to the system requirements and the grounding concept.

Approvals



Measuring transducer repeater power supply, Ex i

MACX MCR-EX-SL-RPSSI-I
Order No. 2865340

MACX MCR-EX-SL-RPSSI-2I
Order No. 2865366

MACX MCR-EX-SL-RPSS-2I-2I
Order No. 2865382

MACX MCR-EX-SL-RPSSI-I-UP
Order No. 2865793

For more devices, visit our
website



Repeater power supply/3-way isolator

MINI MCR-2-UI-UI
Order No. 2902037

MINI MCR-2-I-I
Order No. 2901998

MINI MCR-2-RPSS-I-I
Order No. 2902014

For more devices, visit our
website



Inline I/O bus coupler

IL PN BK DI8 DO4 2TX-PAC
Order No. 2703994 (PROFINET)

IL PB BK DI8 DO4/EF-PAC
Order No. 2692332 (PROFIBUS DP)

IL MOD BK DI8 DO4-PAC
Order No. 2878696 (Modbus/RTU)

IL ETH BK DI8 DO4 2TX-PAC
Order No. 2703981 (Modbus/TCP)



I/O terminals and power supply unit

IB IL EX-IS AIO 4/EF-PAC
Order No. 2869912 (Ex i)

IB IL AI 2/SF-PAC
Order No. 2861302

IB IL AI 8/SF-PAC
Order No. 2861412

IB IL AI 2-HART-PAC
Order No. 2862149

IB IL EX-IS PWR IN-PAC
Order No. 2869910

ATEX, IECEx, UL, SIL, etc.

ATEX, UL, etc.

ATEX, UL-EX

ATEX



Surge protection 24 V DC signals

PT IQ-1x2-24DC-UT
Order No. 2800976

PT IQ-1x2-24DC-PT
Order No. 2801255

PT IQ-2x1-24DC-UT
Order No. 2800787

PT IQ-2x1-24DC-PT
Order No. 2801247

For all common
analog and binary signals



Ex i intrinsically safe surge protection

PT IQ-1x2-EX-24DC-UT
Order No. 2801512

PT IQ-2x2-EX-24DC-UT
Order No. 2801513

LIT 1X2-24
Order No. 2804610

ATEX Ex II 1G Ex [ia] IIC T4, IECEx,
UL-EX, SIL Assessment



Surge protection field devices for 1/2"

S-PT-EX(I)-24DC-1/2" Ex i
Order No. 2882572

S-PT-EX-24DC-1/2" * Ex i/Ex d
Order No. 2800035

S-PT-2XEX-24DC-1/2" * Ex i/Ex d
Order No. 2800041

S-PT-4-EX-24DC-1/2" * Ex i/Ex d
Order No. 2800037

ATEX Ex II 1G Ex [ia] IIC T4, IECEx,
SIL
*ATEX Ex d IIC T4



Ex surge protection field devices

S-PT-EX(I)-24DC Ex i
Order No. 2880671

S-PT-EX-24DC * Ex i/Ex d
Order No. 2800034

S-PT-2XEX-24DC * Ex i/Ex d
Order No. 2800040

S-PT-4-EX-24DC * Ex i/Ex d
Order No. 2800036

ATEX Ex II 1G Ex [ia] IIC T4, IECEx,
SIL Assessment
*ATEX Ex d IIC T4

Solutions for analog output signal processing

Phoenix Contact offers comprehensive solutions for connecting analog output signals from the field level to process control systems. They include measuring transducers, signal conditioners, and repeater power supplies, such as the Inline I/O remote control system.

Suitable surge protection and system cabling solutions complete the turn-key solution.

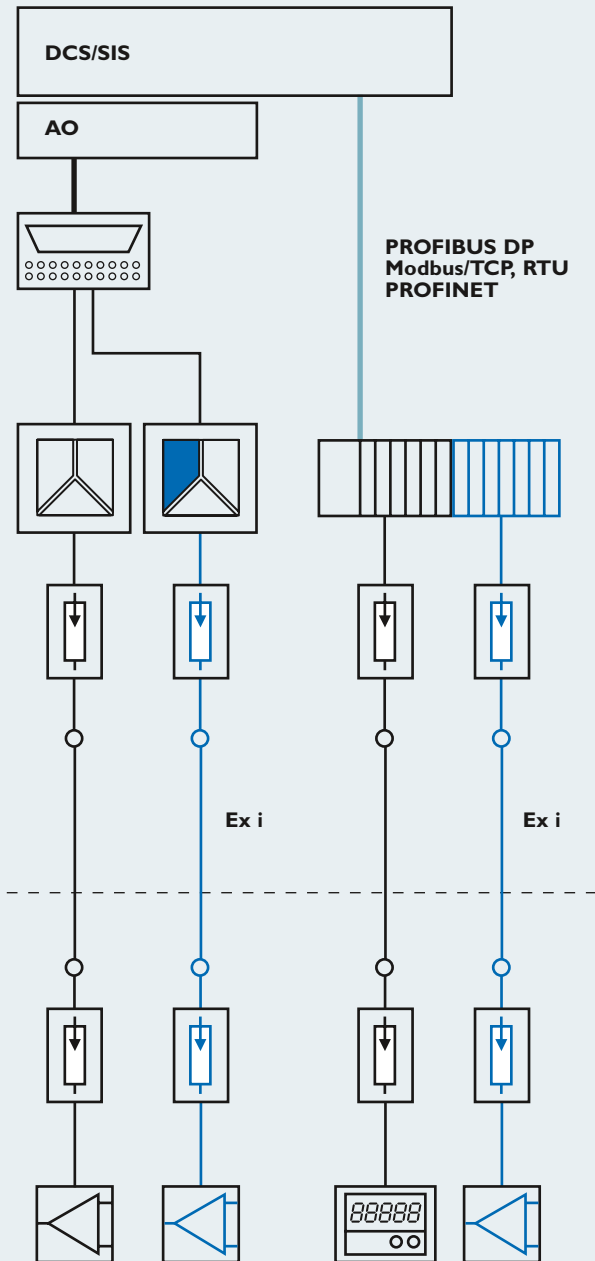

3-way/output signal conditioner

MACX MCR-UI-UI-NC
Order No. 2811446

MACX MCR-UI-UI-UP-NC
Order No. 2811297

MACX MCR-SL-IDS-I
Order No. 2865971

For more devices, visit our website

Approvals

ATEX, IECEx, UL, SIL, etc.

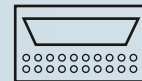

Uni system cabling

VIP-2/SC/D 9SUB/M
Order No. 2315117

CABLE-D 9SUB/B/S/ 50/KONFEK/S
Order No. 2299987

You can choose surge protection modules according to the system requirements and the grounding concept.

Approvals



Output signal conditioner, Ex i

MACX MCR-EX-SL-IDS-I
Order No. 2865405

MACX MCR-EX-SL-IDS-I-SP
Order No. 2924032

3-way signal conditioner

MINI MCR-2-UI-UI
Order No. 2902037

MINI MCR-2-I-I
Order No. 2901998

MINI MCR-SL-IDS-I-I
Order No. 2905577

MINI MCR-SL-I-I
Order No. 2864406

For more devices, visit our website

Inline I/O bus coupler

IL PN BK DI8 DO4 2TX-PAC
Order No. 2703994 (PROFINET)

IL PB BK DI8 DO4/EF-PAC
Order No. 2692332 (PROFIBUS DP)

IL MOD BK DI8 DO4-PAC
Order No. 2878696 (Modbus/RTU)

IL ETH BK DI8 DO4 2TX-PAC
Order No. 2703981 (Modbus/TCP)

I/O terminals and power supply unit

IB IL EX-IS AIO 4/EF-PAC
Order No. 2869912 (Ex i)

IB IL AO 1/SF-PAC
Order No. 2861315

IB IL EX-IS PWR IN-PAC
Order No. 2869910

ATEX, IECEx, UL, SIL, etc.

ATEX, UL, etc.

ATEX, UL-EX

ATEX



Surge protection with status indication

PT-IQ-2X1-24DC-UT
Order No. 2800787

PT-IQ-2X1+F-24DC-UT*
Order No. 2800788

PT-IQ-PTB-UT Controller module
Order No. 2800768

PT-IQ-1x2-24DC-UT
Order No. 2800976

Ex i surge protection

LIT 1X2-24
Order No. 2804610

LIT 2X2-24*
Order No. 2804623

Ex i surge protection

TT-EX(I)-M-24DC
Order No. 2803865

TT-EX(I)-24DC
Order No. 2832124

TT-ST-M-EX(I)-24DC
Order No. 2859424

Ex surge protection field devices

S-PT-EX(I)-24DC
Order No. 2880671

S-PT-EX-24DC*
Order No. 2800034

S-PT-2XEX-24DC*
Order No. 2800040

S-PT-4-EX-24DC*
Order No. 2800036

- / *indirect grounding
UL

ATEX Ex II 1G Ex [ia] IIC T4, IECEx,
UL, SIL *2 channels

ATEX Ex II 1G Ex [ia] IIC T4

ATEX Ex II 1G Ex [ia] IIC T4, IECEx,
UL, SIL *ATEX Ex d IIC T4

Solutions for digital input signal processing

Comprehensive solutions are available for connecting digital input signals from the field level to process control systems. They include coupling relays, NAMUR signal conditioners, and safety relays, as well as the Inline I/O remote control system.

Suitable surge protection and system cabling solutions complete the turn-key solution.



NAMUR signal conditioner, Ex i

MACX MCR-EX-SL-2NAM-RO
Order No. 2865476

MACX MCR-EX-SL-NAM-2RO
Order No. 2865450

MACX MCR-EX-SL-2NAM-T
Order No. 2865489

Approvals

ATEX, IECEx, UL, SIL, etc.

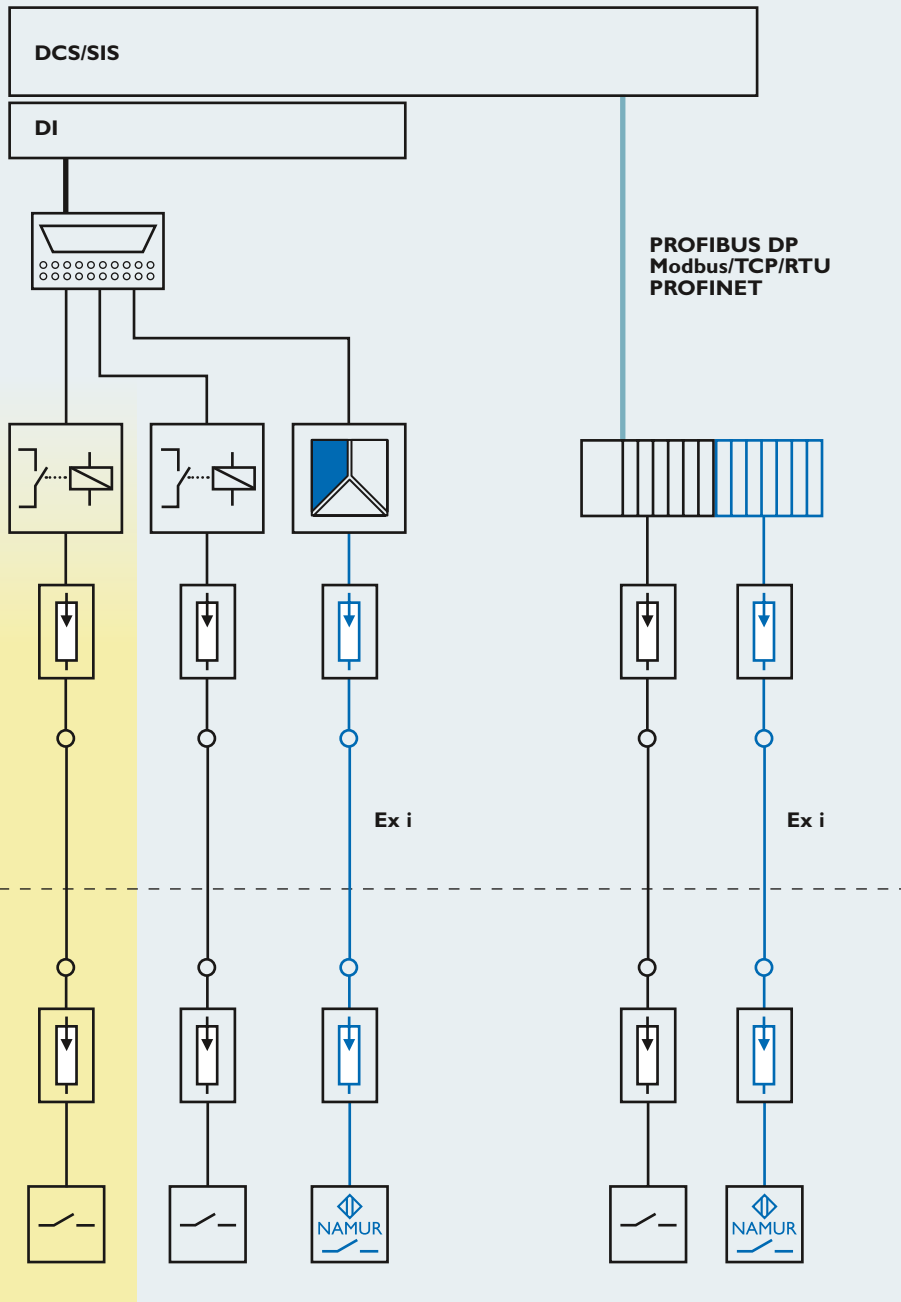

You can find suitable surge protection for digital input signal processing on the previous and following pages.

You can choose surge protection modules according to the system requirements and the grounding concept.



NAMUR signal conditioner, 2-channel

MACX MCR-SL-2NAM-RO
Order No. 2865049
MACX MCR-SL-2NAM-RO-SP
Order No. 2924294

ATEX, IECEx, UL, SIL, etc.



Signal conditioner

MINI MCR-2-NAM-2RO
Order No. 2902004
MINI MCR-2-NAM-2RO-PT
Order No. 2902005
MINI MCR-SL-NAM-2RNO
Order No. 2864105
MINI MCR-SL-NAM-2RNO-SP
Order No. 2810269

ATEX, UL, etc.



Inline I/O bus coupler

IL PN BK DI8 DO4 2TX-PAC
Order No. 2703994 (PROFINET)
IL PB BK DI8 DO4/EF-PAC
Order No. 2692332 (PROFIBUS DP)
IL MOD BK DI8 DO4-PAC
Order No. 2878696 (Modbus/RTU)
IL ETH BK DI8 DO4 2TX-PAC
Order No. 2703981 (Modbus/TCP)

ATEX, UL-EX



I/O terminals and power supply unit

IB IL EX-IS DIO 4/NAM-PAC
Order No. 2869911 (Ex i)
IB IL 24 DI 32/HD-PAC
Order No. 2862835
IB IL EX-IS PWR IN-PAC
Order No. 2869910

ATEX



NAMUR switch

PLC-SC-EIK 1-SVN 24P/P
Order No. 2982663
PLC-SC-EIK 1-SVN 24M
Order No. 2982595

Approvals

–

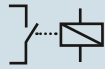

Coupling relay sensor

PLC-RSC- 24DC/ 1/SEN
Order No. 2966223
PLC-RSC- 24DC/ 1AU/SEN
Order No. 2966317
PLC-OSC- 24DC/ 48DC/100/SEN
Order No. 2966773

SIL

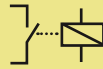

Safety relay

PSR-SCP-24UC/ESAM4/3X1/1X2/B
Order No. 2900509
PSR-SCP-120UC/ESAM4/3X1/1X2/B
Order No. 2901422
PSR-SCP-230UC/ESAM4/3X1/1X2/B
Order No. 2901428
PSR-SCP-24UC/ESP4/2X1/1X2*
Order No. 2981020

UL, GL

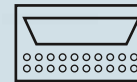

Uni system cabling

VIP-3/SC/D50SUB/F
Order No. 2315201
CABLE-D50SUB/S/S/100/KONFEK/S
Order No. 2305693

–

Solutions for digital output signal processing

Phoenix Contact offers comprehensive solutions for connecting digital output signals from the process control level to the field level. They include coupling relays, solenoid drivers, and safety relays, as well as the Inline I/O remote control system.

Suitable surge protection and system cabling solutions complete the turn-key solution.

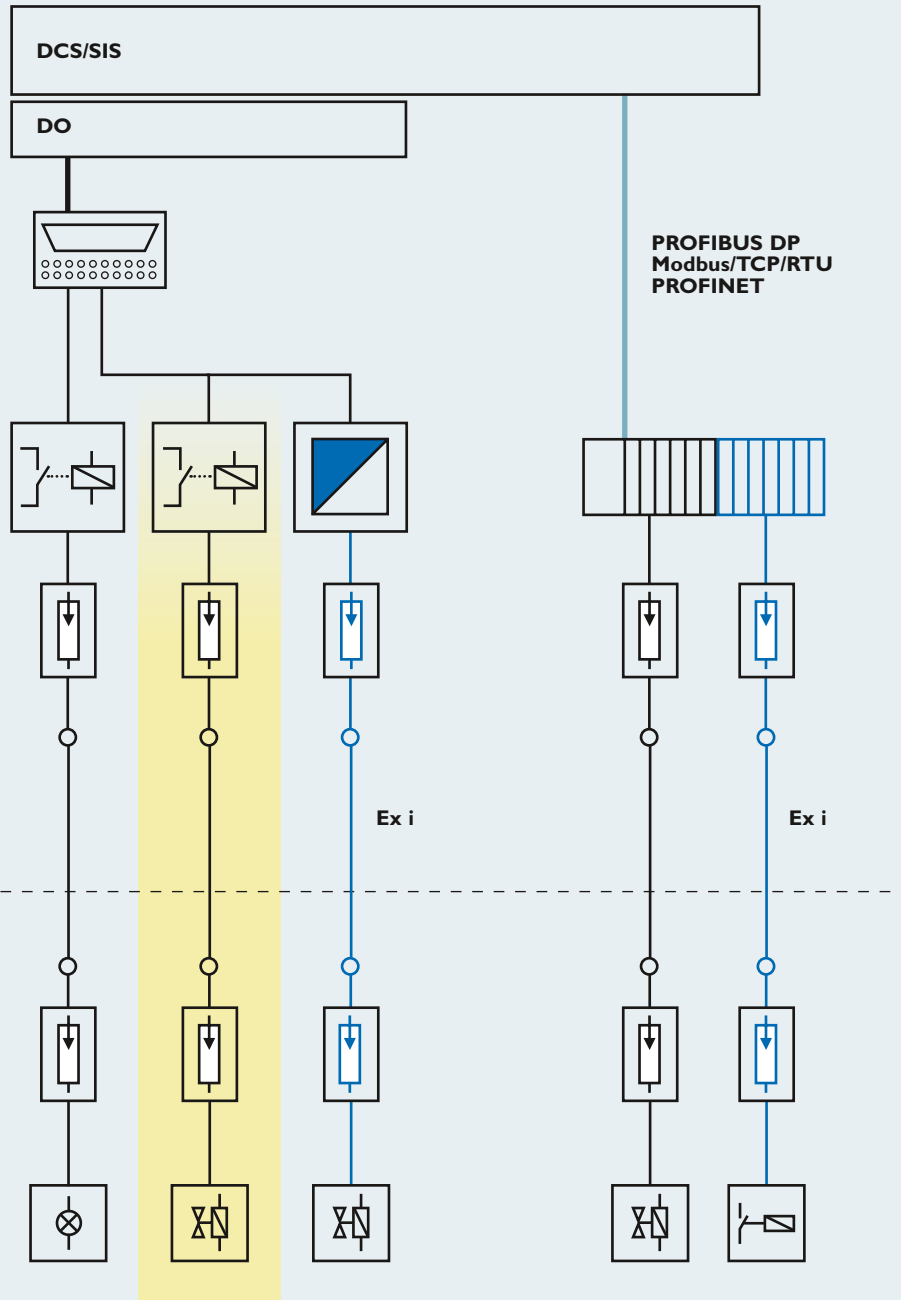

Ex i solenoid driver

MACX MCR-EX-SL-SD-24-48-LP
Order No. [2865609](#)

MACX MCR-EX-SL-SD-24-48-LP-SP
Order No. [2924126](#)

MACX MCR-EX-SL-SD-23-48-LFD
Order No. [2924867](#)

For more Ex i solenoid drivers, visit our website.

Approvals

ATEX, IECEx, UL, SIL, etc.



Coupling relay for Zone 2

PLC-RSC-24DC/21-21/ATEX
Order No. [2980461](#)

PLC-RSC-24DC/21/ATEX
Order No. [2902955](#)

PLC-RSC-120UC/21/ATEX
Order No. [2902956](#)

Approvals

ATEX, UL-EX

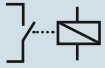

Coupling relay actuator

PLC-RSC- 24DC/ 1/ACT
Order No. 2966210

PLC-RSC- 24DC/ 1- 1/ACT
Order No. 2967109

PLC-OSC- 24DC/ 24DC/ 2/ACT
Order No. 2966676

For more devices, visit our website.

UL, GL

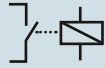

Coupling relay

RIF-0-RPT-24DC/21
Order No. 2903370

RIF-1-RPT-LDP-24DC/2x21
Order No. 2903334

RIF-2-RPT-LDP-24DC/4x21
Order No. 2903308

For more devices, visit our website.

UL, CSA

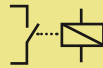

PSR-SIL coupling relay – emergency shut down

PSR-SCP-24DC/FSP/1X1/1X2*
Order No. 2981978

PSR-PS20
Order No. 2700356

PSR-PC20
Order No. 2700577

*SIL3, **SIL2

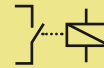

PSR-SIL coupling relay – fire and gas

PSR-SCP-24DC/ETP/1X1
Order No. 2986711

PSR-PC50
Order No. 2904664

PSR-PC50
Order No. 2904665

SIL



Inline I/O bus coupler

IL PN BK DI8 DO4 2TX-PAC
Order No. 2703994 (PROFINET)

IL PB BK DI8 DO4/EF-PAC
Order No. 2692332 (PROFIBUS DP)

IL MOD BK DI8 DO4-PAC
Order No. 2878696 (Modbus/RTU)

IL ETH BK DI8 DO4 2TX-PAC
Order No. 2703981 (Modbus/TCP)

ATEX, UL-EX



I/O terminals and power supply unit

IB IL EX-IS DIO 4/NAM-PAC
Order No. 2869911 (Ex i)

IB IL 24 DO 32/HD-PAC
Order No. 2862822

IB IL EX-IS PWR IN-PAC
Order No. 2869910

ATEX



Surge protection for 24 V DC signals

TT-2-PE-M-24DC
Order No. 2920641

TT-2-PE/S1-M-24DC
Order No. 2920638

TT-2/2- 24DC
Order No. 2838173

TT-2-PE- 24DC
Order No. 2838186

SIL Assessment



Ex i surge protection

PT 2XEX(I)-24DC-ST Plug
Order No. 2838225

PT 2XEX(I)-BE Base
Order No. 2839279

PT 4-EX(I)-24DC-ST Plug
Order No. 2839253

PT 4-EX(I)-BE Base
Order No. 2839486

ATEX Ex II 1G Ex [ia] IIC T4, IECEx, UL-EX, SIL Assessment

Solutions for processing temperature measured values

Comprehensive solutions are available for connecting temperature measured values from the field level to process control systems. They include measuring transducers in a wide range of versions, as well as the Inline I/O remote control system.

Suitable surge protection and system cabling solutions complete the turn-key solution.

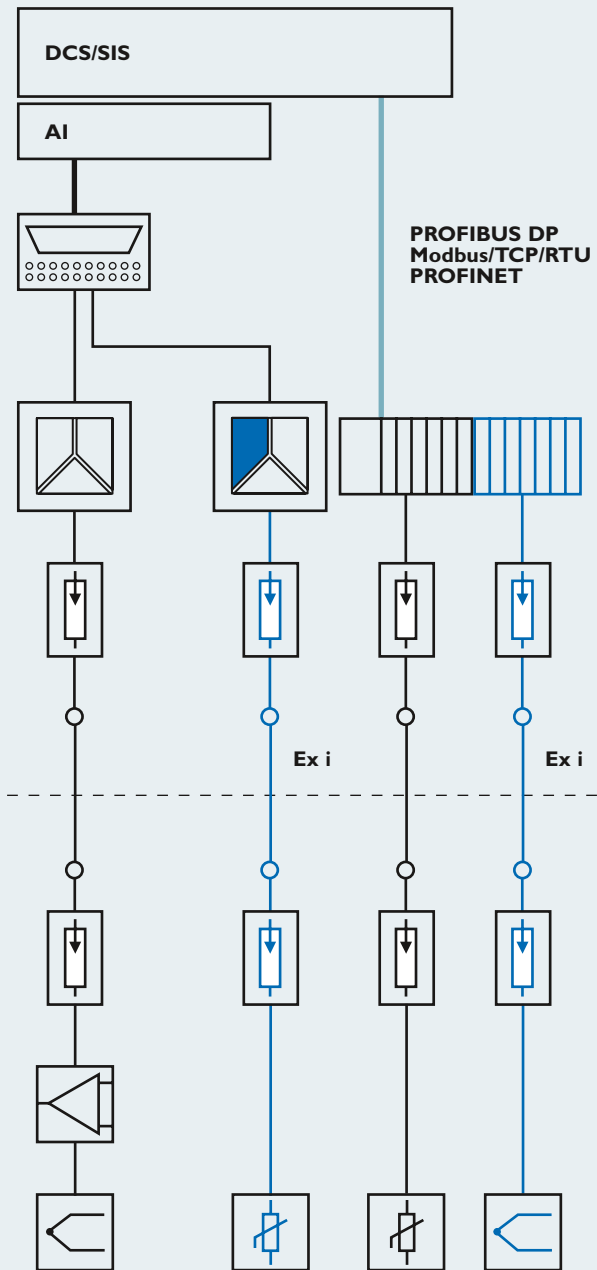

Head-mounted temperature transducer

MCR-SL-HT-PT 100-I

Order No. [2864516](#)

MCR-FL-HT-T-I

Order No. [2864529](#)

You can choose surge protection modules according to the system requirements and the grounding concept.

Approvals

ATEX, UL



Temperature transducer

- MACX MCR-SL-RTD-I**
Order No. [2865939](#)
- MACX MCR-SL-TC-I**
Order No. [2865942](#)
- MACX MCR-T-UI-UP**
Order No. [2811394](#)
- MACX MCR-T-UIREL-UP**
Order No. [2811378](#)

Temperature transducer, Ex i

- MACX MCR-EX-SL-RTD-I**
Order No. [2865939](#)
- MACX MCR-EX-SL-TC-I**
Order No. [2865942](#)
- MACX MCR-EX-T-UI-UP**
Order No. [2865654](#)
- MACX MCR-EX-T-UIREL-UP**
Order No. [2865751](#)

Temperature transducer

- MINI MCR-2-RTD-UI**
Order No. [2902049](#)
- MINI MCR-2-TC-UI**
Order No. [2902055](#)
- For more devices, visit our [website](#)

I/O terminals and power supply unit

- IB IL EX-IS TEMP4RTD/TC-PAC**
Order No. [2869913](#)
- IB IL TEMP 2 RTD-PAC**
Order No. [2861328](#)
- IB IL TEMP 2 UTH-PAC**
Order No. [2861386](#)
- IB IL EX-IS PWR IN-PAC**
Order No. [2869910](#)

Approvals

ATEX, IECEx, UL, SIL, etc.

ATEX, IECEx, UL, SIL, etc.

ATEX, UL, etc.

ATEX



Head-mounted temperature transducer

- MCR-FL-HT-T-I-EX**
Order No. [2864532](#)
- MCR-FL-HT-TS-I-EX**
Order No. [2864545](#)

Surge protection for 24 V DC signals

- PT 4X1-24DC-ST**
Order No. [2838322](#)
 - PT 4X1-BE**
Order No. [2839363](#)
 - PT 4X1+F-BE**
Order No. [2839376](#)
 - LIT 4X1-24**
Order No. [2804636](#)
- Plug
- Base
- Base, floating

Ex i surge protection

- PT 4-EX(I)-24DC-ST**
Order No. [2839253](#)
 - PT 4-EX(I)-BE**
Order No. [2839486](#)
 - Alternative:
LIT 4-24
Order No. [2804678](#)
- Plug
- Base

Ex surge protection field devices

- S-PT-EX(I)-24DC**
Order No. [2880671](#)
- S-PT-EX-24DC***
Order No. [2800034](#)
- S-PT-2XEX-24DC***
Order No. [2800040](#)
- S-PT-4-EX-24DC***
Order No. [2800036](#)

ATEX II 1 G EEx [ia] IIC T6, SIL

–

ATEX Ex II 1G Ex [ia] IIC T4, IECEx, UL, SIL

ATEX Ex II 1G Ex [ia] IIC T4, IECEx, SIL *ATEX Ex d IIC T4

Solutions for applications with HART communication

The bidirectional HART-capable devices in the MACX series enable HART information to be integrated into separate engineering and management systems via the MACX MCR-S-MUX HART multiplexer and the corresponding wiring modules. Corresponding COMSERVERs also support further processing via Ethernet. This also means that limit and diagnostic values, as well as information such as the calibration state or the status of intelligent field devices can be integrated impact-free into process control systems and remote calibration can be performed.

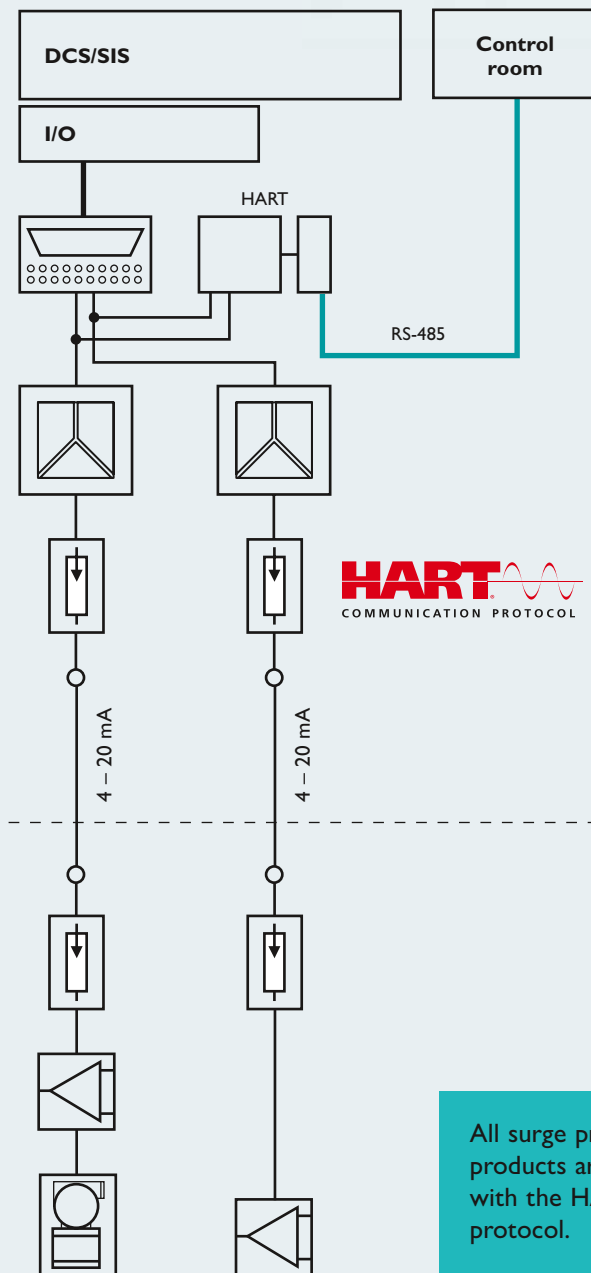

All surge protection products are compatible with the HART protocol.



HART communication

MACX MCR-S-MUX
Order No. 2865599

MACX MCR-S-MUX-TB
Order No. 2308124

Description

- 16 or 32 channels per multiplexer
- Connection of max. 4000 HART signals



HART communication

FL COMSERVER BASIC 232/422/485
Order No. 2313478

Description

- Transmission of up to 32 channels
- Conversion of HART signals to Ethernet via COMSERVER

Solutions with various protocols

A wide range of fieldbus systems can be easily integrated into your process system. The new gateways (GW PL FB...) enable the easy integration of a wide range of fieldbus systems and the networking of existing field instruments and data in your system. Existing Modbus or HART information is reliably converted to modern fieldbus systems, such as PROFIBUS DP, PROFIBUS PA or FOUNDATION Fieldbus. You can therefore also easily connect your existing measuring devices that are installed in the field to new, future network infrastructures.



Protocol converter

GW PL FB/FF-HART

Order No. [2316360](#)

GW PL FB/PA-HART

Order No. [2316361](#)

GW PL FB/DP-HART

Order No. [2316362](#)

GW PL FB/FF-MODBUS

Order No. [2316363](#)

GW PL FB/PA-MODBUS

Order No. [2316364](#)

GW PL FB/DP-MODBUS

Order No. [2316365](#)

Description

- Access to digital data from Modbus and HART devices in the field
- Extended runtime for special measuring instruments and otherwise inaccessible data
- Reliable conversion from existing networks to faster communication paths

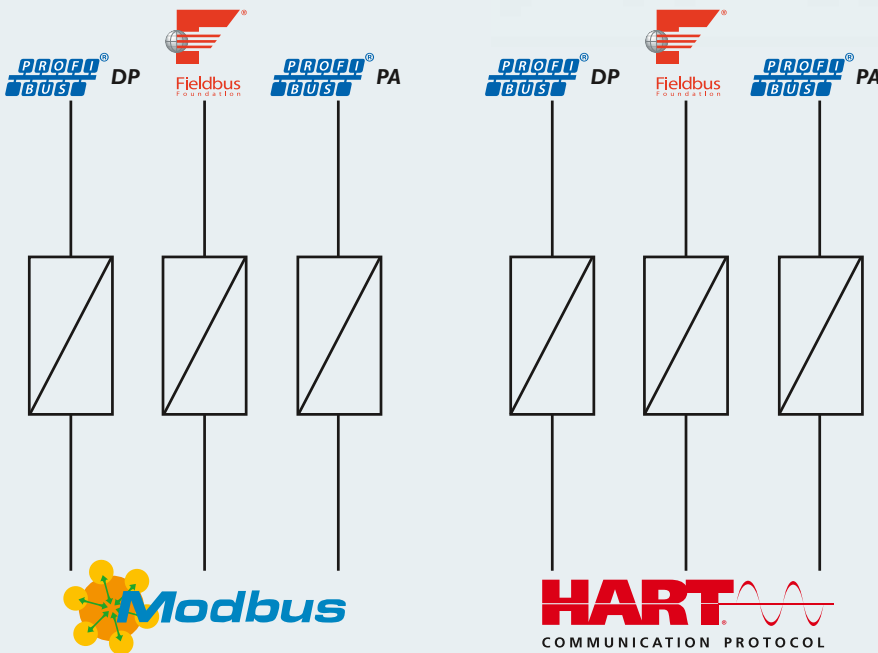

The PL FB protocol converter has four channels for connecting Modbus or HART devices to fieldbus systems such as PROFIBUS DP, PROFIBUS PA or FOUNDATION Fieldbus devices.

Solutions for applications with WirelessHART

Conventional analog field devices which are connected to non-HART-capable process control systems can be extended easily and without needing to replace the existing control hardware by using WirelessHART networks. On field devices that are already hardwired, WirelessHART adapters can be used to connect to a WirelessHART/WLAN gateway. A wide range of parameterization and diagnostic functions can therefore be integrated into the existing system without having to stop the process.

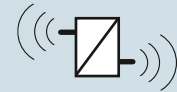
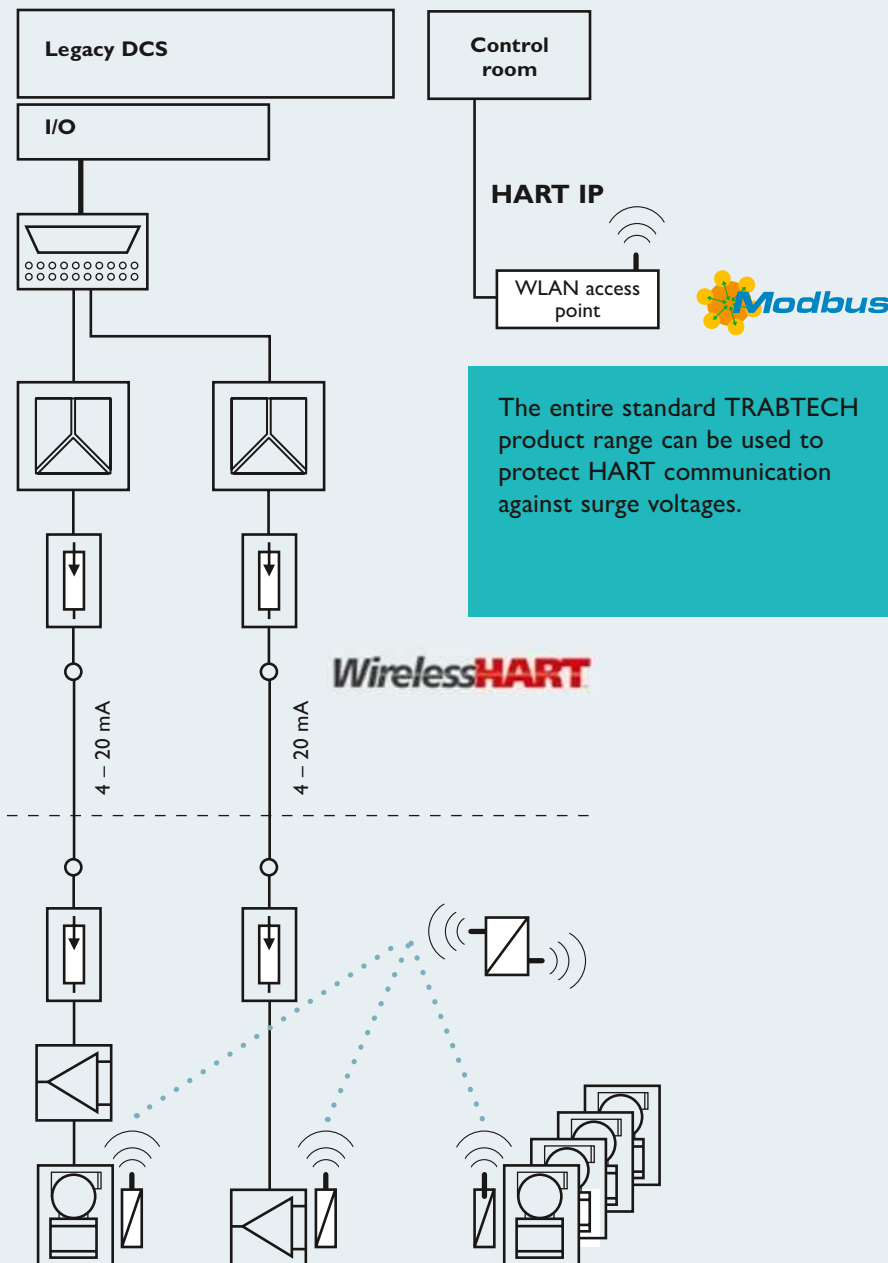

WirelessHART/ WLAN gateway

RAD-WHG/WLAN-XD
Order No. 2900178

Description

- Connects up to 250 WirelessHART field devices
- Converts HART data to Modbus/TCP and HART IP
- Easy startup thanks to integrated web server



WirelessHART adapter

RAD-WHA-1/2NPT
Order No. 2900100

Description

- Connects up to four HART-capable devices or one conventional 4 to 20 mA field device
- External or loop supply
- Housing with IP65 protection

Solutions for Ethernet applications with HART

The modular Ethernet HART multiplexer enables access to HART-capable field instruments via familiar Ethernet-based fieldbuses such as PROFINET, Modbus/TCP, and HART IP. Each device has a separate HART master which can be connected to higher-level fast Ethernet network infrastructures. Up to 40 HART devices can be connected to existing configuration tools such as PACTware, Simatic PDM, Honeywell FDM, HART OPC server or HART server. System operators therefore save time and costs since configuration and calibration, e.g., partial stroke test, process monitoring or current loop tests, are controlled via Ethernet and everything can be performed during active operation.

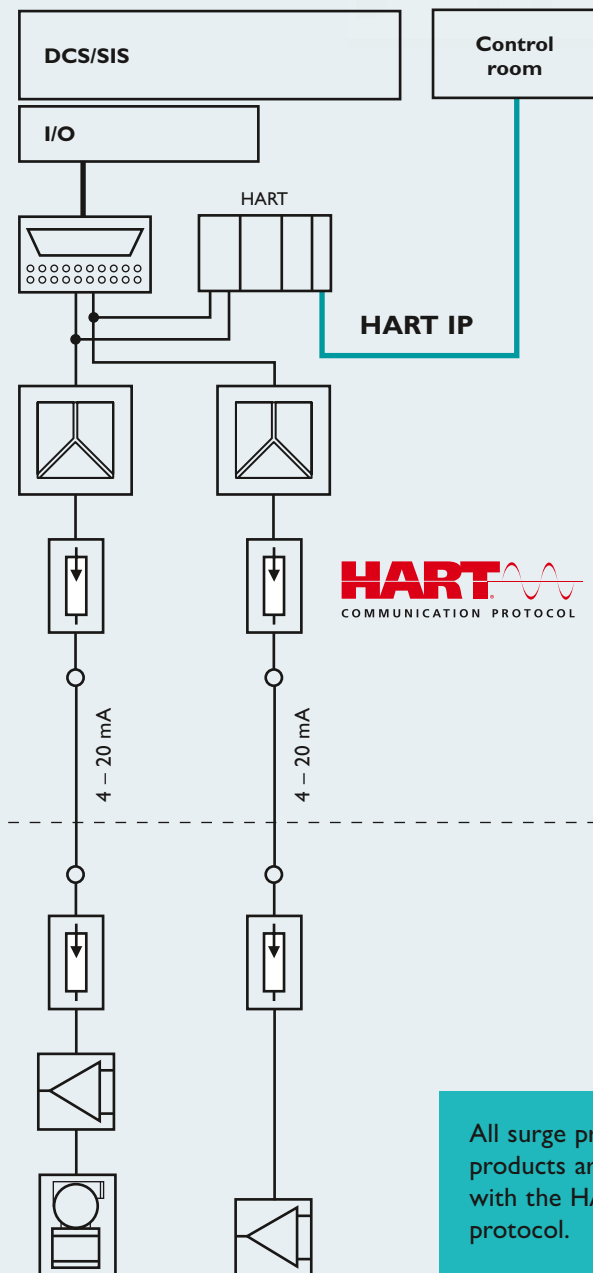

All surge protection products are compatible with the HART protocol.



Modular Ethernet HART multiplexer

GW PL ETH/UNI-BUS
Order No. [2702233](#)

GW PL ETH/BASIC-BUS
Order No. [2702321](#)

GW PL HART4-BUS
Order No. [2702234](#)

GW PL HART8-BUS
Order No. [2702235](#)

GW PL HART8+AI-BUS
Order No. [2702236](#)

GW PL DIO4-BUS
Order No. [2702237](#)

Description

- Modular design – up to 40 HART devices can be connected
- Converts HART protocols to HART IP, Modbus/TCP or PROFINET
- For the fastest possible data access, each HART connection has a separate HART master

EMpro meters – monitor energy flow and communicate energy data

Use network-capable EMpro meters to monitor characteristic electrical data centrally and on site. Plug-in communication modules allow you to flexibly integrate the EMpro meters into network structures and fieldbus systems.

This means that measured values can even be made available in the control center for further processing.

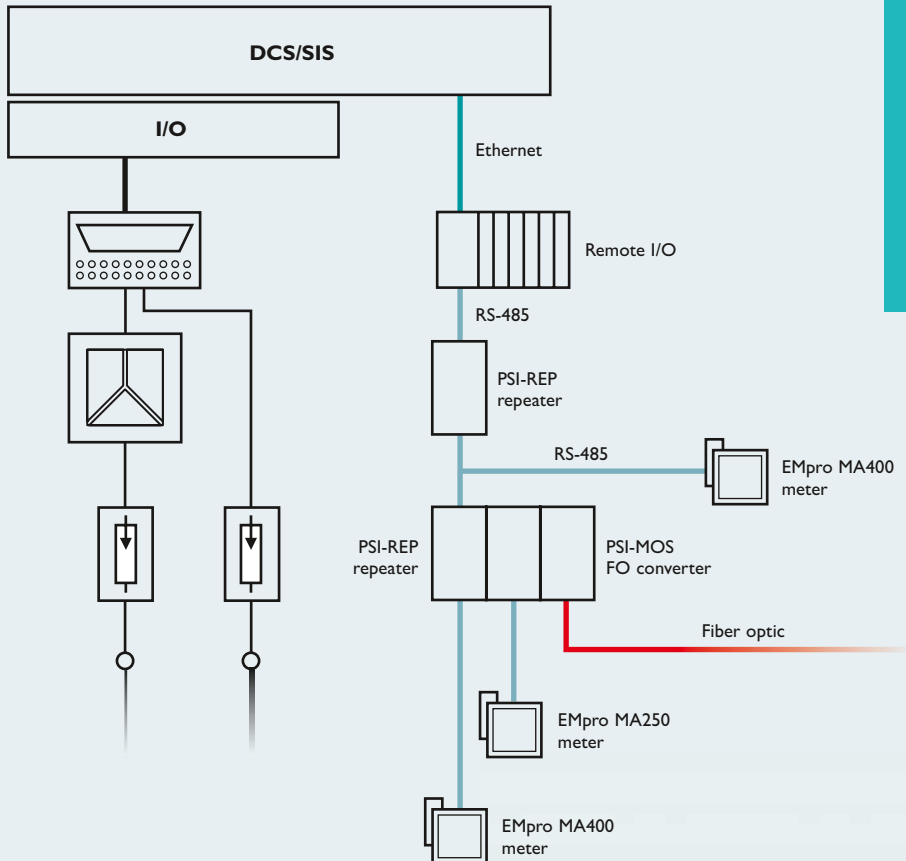

Your advantages:

- Direct access to measured values – directly on the device or remotely from the host computer
- User-friendly configuration – on site by following the operator guidance or via the integrated web server
- Easy integration in network structures, thanks to flexible connection options
- High degree of planning reliability and investment security, thanks to expansion with additional function and communication modules

Remote access to multiple meters – with just one IP address

The web server that has been integrated into the Ethernet communication modules allows you to conveniently configure key parameters online. It also allows remote access to key electrical characteristics such as current, voltage, power, energy, and harmonics.

In your monitoring network, the master consists of an EMpro MA600 meter, combined with an Ethernet gateway. You can easily configure the connected energy meters as slaves via the web server interface. You can therefore access all energy data – with just one IP address.



The DIN rail adapter enables EMpro MA600 and EMpro MA400 built-in devices to also be mounted on the DIN rail.

EEM-MKT-DRA
Order No. 2902078



EMpro MA600

EEM-MA600
Order No. 2901366
EEM-MA600-24DC
Order No. 2902352

EMpro MA400

EEM-MA400
Order No. 2901364

EMpro MA200/250

EEM-MA200
Order No. 2901362
EEM-MA250
Order No. 2901363

Measurement

Voltage measurement

Directly up to 700 V or voltage transducer

Directly up to 519 V

Directly up to 519 V

Current measurement

Current transformer

Current transformer

Current transformer

Frequency

•

•

•

Real power, reactive power, apparent power (+/-)

•

•

•

Power factor

•

•

•

Maximum mean values

•

•

•

Mean values

•

Trend performances

•

Real energy meter (kWh)

kWh+ / kWh-

kWh+

kWh+

Reactive energy meter (kvarh)

kvarh+ / kvarh-

kvarh+

kvarh+

Apparent energy meter (kVAh)

kVAh

Operating hours counter

•

•

•

Accuracy class (EN 62053-22)

0.5 S

0.5 S

0.5 S

Harmonic content

Up to 63rd

Up to 51st

Up to 51st

Spectral analysis

Up to 63rd

Function modules (optional)

1 pulse or alarm output

EEM-IMP-MA400
Order No. 2904314

Integrated

2 pulse outputs

EEM-IMP-MA600
Order No. 2904313

2 digital inputs, 2 digital outputs

EEM-2DIO-MA600
Order No. 2901371

2 analog outputs

EEM-2AO-MA600
Order No. 2901475

3 Pt100 temperature inputs and 1 internal temperature measurement

EEM-TEMP-MA600
Order No. 2901949

Memory

EEM-MEMO-MA600
Order No. 2901370

Communication modules (optional)

RS-485 (Modbus/RTU)

EEM-RS485-MA600
Order No. 2901367

EEM-RS485-MA400
Order No. 2901365

Integrated (MA250 only)

D-SUB (PROFIBUS)

EEM-PB12-MA600
Order No. 2901418

Ethernet gateway (Modbus/TCP/RTU) with web server

EEM-ETH-RS485-MA600
Order No. 2901374

Ethernet (Modbus/TCP) with web server

EEM-ETH-MA600
Order No. 2901373

Key

I1, I2, I3
IN

Conductor currents
Neutral conductor current,
phase conductor voltages

U12, U23, U31
V1, V2, V3
P

Phase/phase
Phase/N conductor voltages
Real power

Q
S
PF
THD
Σ

Reactive power
Apparent power
Power factor P/S
Total harmonic distortion
Total values

Solutions for intelligent motor control and monitoring

Three-phase pumps, agitators or actuators can be monitored and controlled via a central controller. Communication is established either via gateways (e.g., PROFIBUS gateway) or a small-scale controller, which transmits the sensor data (here EMM) using an I/O module. The switching device (ELR) is controlled via the EMM.

Motors up to 4 kW can be started using ELR hybrid motor starters.

For higher power ratings and current strengths, only ELR series solid-state contactors should be used.

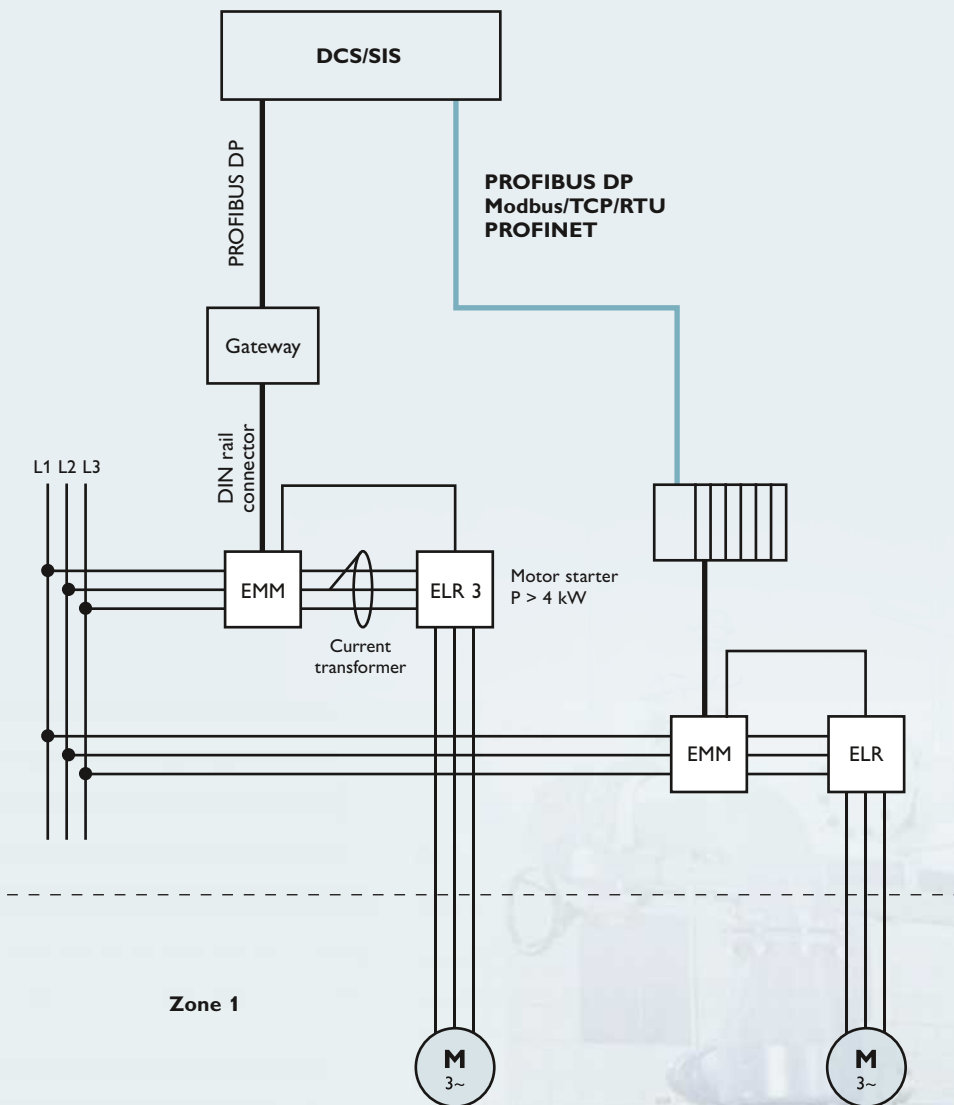

Technical data

Approvals

Input voltage range

Output voltage range

Maximum load current

Ambient temperature



EMM

ELR

ELR 3

Electronic motor management

Hybrid motor starters

Solid-state contactors

Accessories

EMM 3-24DC/500AC-16-IFS
Order No. [2297523](#)
EMM 3-24DC/500AC-IFS
Order No. [2297497](#)

ELR H5-IES-SC- 24DC/500AC-2
Order No. [2900414](#)
ELR H5-IES-SC- 24DC/500AC-9
Order No. [2900421](#)
ELR H3-IES-SC- 24DC/500AC-2
Order No. [2900567](#)
ELR H3-IES-SC- 24DC/500AC-9
Order No. [2900569](#)
ELR H5-SC- 24DC/500AC-9
Order No. [2900538](#)
ELR H3-SC- 24DC/500AC-9
Order No. [2900530](#)

ELR 3-24DC/500 AC-16
Order No. [2297235](#)
ELR 2+1- 24DC/500AC-37
Order No. [2297277](#)
ELR W3- 24DC/500AC-16
Order No. [2297332](#)
ELR W 2+1- 24DC/500AC-37
Order No. [2297374](#)

IB IL IFS-MA-PAC
Order No. [2692720](#)
EM-PB-GATEWAY-IFS
Order No. [2297620](#)
MM-CONF-SET
Order No. [2297992](#)
PACT MCR-V1-21-44-100-5A-1
Order No. [2277022](#)
PACT MCR-V1-21-44-150-5A-1
Order No. [2277035](#)
PACT MCR-V2-5012- 85- 150-5A-1
Order No. [2276117](#)
PACT MCR-V2-5012- 85- 250-5A-1
Order No. [2276133](#)
For over 3300 more versions, visit our website

PTB ATEX, UL Listed CUL
19.2 V DC ... 30 V DC
42 V AC ... 575 V AC
< 16 A/
> 16 A with external current transformer
-25°C to +70°C

PTB ATEX (IES devices),
UL Listed CUL 508
19.2 V DC ... 30 V DC
48 V AC ... 550 V AC
2.4 A/9 A
-25°C to +70°C

UL Listed CUL
19.2 V DC ... 30 V DC
48 V AC ... 550 V AC
16 A/37 A
-25°C to +70°C

The comprehensive range of accessories consists of current transformers, fieldbus gateways, software, and many other products relating to intelligent motor control.



Switching and monitoring motor-driven pumps, agitators or actuators. Through electronic motor management with real power monitoring and by choosing suitable switching thresholds, dry running or a clogged filter can be detected and reported. An emergency shutdown can be performed if necessary. The availability and service life of the system is increased. The use of external current transformers ensures measuring technology performance is not restricted. The system is integrated into a BUS system via gateways or ILC small-scale controllers.

System cabling for process control systems

Wiring I/O modules with single wires (Figure 1) is an extremely time-consuming process. Wiring errors and tedious troubleshooting cannot be ruled out. Interface cabling reduces assembly costs by using plug-in components to carry out wiring quickly, clearly, and without errors. With VARIOFACE system cabling (Figure 2), it is possible to connect numerous I/O modules from renowned DCS and safety system manufacturers.

VARIOFACE system cabling – error-free and uniform I/O wiring

Phoenix Contact offers solutions for the following DCS and safety system manufacturers:

- ABB
- Emerson
- Honeywell
- Siemens
- Yokogawa

Depending on the control system, the system configuration consists of up to three components:

- VARIOFACE front adapter
- VARIOFACE system cable
- VARIOFACE termination board

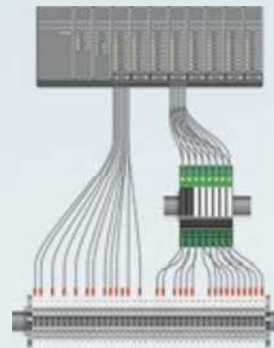

Figure 1: Example of control cabinet cabling with single signal conductors

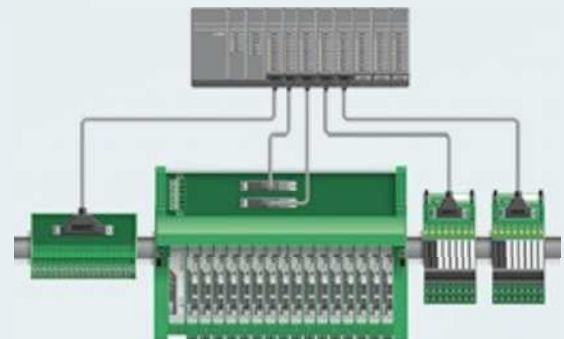

Figure 2: Example of control cabinet wiring with front adapters, pre-assembled system cables, and termination boards

Push-in Technology

Designed by PHOENIX CONTACT

Connection is space-saving, vibration resistant, and variable in terms of the marking and connection options. Various modules offer a wide range of possible applications. The DCS and safety system signals can therefore be transmitted passively to the field, i.e., as a 1:1 connection, using the termination boards. Active modules with relay or solid-state relay (optocoupler) can be used to adapt signals to different switching levels, amplify signals or electrically isolate signals between the controller and field.

System cabling solution for various DCS

ABB

The ABB S800 I/O system offers the option of carrying out wiring via D-SUB connections. The ABB TU812 system with modular termination unit (MTU) is available for this purpose. Phoenix Contact offers comprehensive cabling solutions for this.

Emerson

The Emerson DeltaV system offers the option of carrying out process wiring via mass termination blocks (MTBs) with flat-ribbon cable connections. Phoenix Contact offers suitable flat-ribbon cables in various designs for this.

Honeywell

Using the intelligent VARIOFACE solution, the I/O signals of the Honeywell C series can be converted or amplified easily – while saving space at the same time. Simply plug the front adapters onto the I/O cards and connect them to the VARIOFACE termination boards via assembled system cables.

Siemens

VARIOFACE Professional for SIMATIC S7-300/ET 200M. The pre-assembled front adapters with integrated cable can be installed on the field side on a termination board or a terminal block from the “COMBI plug-in connection solutions” series. This extensive product range can be used to connect almost all S7-300 I/O modules to the field without any errors – for optimum integration in the Siemens process control system.

Yokogawa

The I/O signals of the Yokogawa CENTUM® VP, CENTUM® CS 3000 R3 or STARDOM™ can be easily connected to the VARIOFACE termination boards using pre-assembled system cables. The products available range from simple 1:1 termination boards and fuse modules to relay modules.



Termination Carriers

Consistent interface solutions for system technology

The Termination Carrier is a compact solution for the quick and error-free connection of standard interfaces to the automation system. Signal connection is by means of Plug and Play using standardized system cables.

The following standard DIN rail devices are available for safe signal conditioning:

- Signal conditioners for Ex i circuits and SIL applications
- 6.2 mm signal conditioners for non-Ex i circuits
- Safe coupling relays for process automation

Space-saving and fast installation

The compact Termination Carrier solution enables you to integrate up to 384 signals in an 80 x 200 cm control cabinet when using 2-channel MACX Analog Ex devices.

Mounting and startup can be carried out quickly and without any errors using pre-assembled system cables.

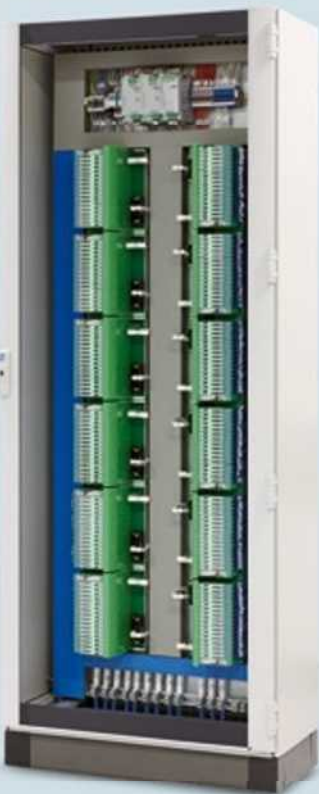

For system cables with pin and socket strip or with open end, plus all the necessary cable sets for connecting the safety relays to the Termination Carrier, visit phoenixcontact.net/products.



MINI Analog Termination Carrier

MINI Analog Pro Termination Carrier

MACX Analog Ex Termination Carrier

PSR Termination Carrier

TC-D37SUB-ADIO16-M-P-UNI
Order No. [2902933](#)

For 16 MINI Analog devices plus 1 x power terminal and 1 x fault signaling module with 1:1 pinning on DSUB37.

TC-D37SUB-ADIO16-MP-P-UNI
Order No. [2906639](#)

For 16 MINI Analog Pro devices plus 1 x power terminal and 1 x fault signaling module with 1:1 pinning on DSUB37.

TC-D37SUB-ADIO16-EX-P-UNI
Order No. [2924854](#)

For 16 MACX Analog Ex devices plus 1 x power module with 1:1 pinning on DSUB37.

TC-2D37SUB-DO16-ESD-AR-UNI
Order No. [2902913](#)

For 16 PSR coupling relays for safely interrupting circuits with 1:1 pinning on DSUB37.

TC-D37SUB-AIO16-M-PS-UNI
Order No. [2902934](#)

For 16 MINI Analog devices plus 1 x power terminal and 1 x fault signaling module with 1:1 pinning on DSUB37 and additional option of HART decoupling.

TC-D37SUB-ADIO16-MP-PS-UNI
Order No. [2906640](#)

For 16 MINI Analog Pro devices plus 1 x power terminal and 1 x fault signaling module with 1:1 pinning on DSUB37 and additional option of HART decoupling.

TC-D37SUB-AIO16-EX-PS-UNI
Order No. [2902932](#)

For 16 MACX Analog Ex devices plus 1 x power module with 1:1 pinning on DSUB37 and additional option of HART decoupling.

TC-2D37SUB-DO16-F&G-AR-UNI
Order No. [2902914](#)

For 16 PSR coupling relays for safely switching on circuits with 1:1 pinning on DSUB37.

Termination Carriers for PSRmini are available on request.

MINI Analog signal conditioner

MINI Analog Pro signal conditioner

MACX Analog Ex signal conditioner

PSR* safety relay

Analog input

MINI MCR-SL-RPSS-I-I
Order No. [2864079](#)

MINI MCR-SL-UI-UI-NC
Order No. [2864150](#)

Analog output

MINI MCR-SL-IDS-I-I
Order No. [2905577](#)

Digital input

MINI MCR-SL-NAM-2RNO
Order No. [2864105](#)

MINI MCR-SL-NAM-2RNO-SP
Order No. [2810269](#)

Power terminal

MINI MCR-SL-PTB-FM
Order No. [2902958](#)

Fault signaling module

MINI MCR-SL-FM-RC-SP-NC
Order No. [2902962](#)

Analog input

MINI MCR-SL-RPSS-I-I
Order No. [2902040](#)

Digital input

MINI MCR-SL-NAM-2RNO
Order No. [2902005](#)

Power terminal

MINI MCR-SL-PTB-FM
Order No. [2902067](#)

Fault signaling module

MINI MCR-SL-FM-RC-SP-NC
Order No. [2904508](#)

Analog input

MACX MCR-EX-SL-RPSSI-I
Order No. [2865340](#)

MACX MCR-SL-RPSSI-I
Order No. [2865955](#)

Analog output

MACX MCR-EX-SL-IDS-I-I
Order No. [2865405](#)

MACX MCR-SL-IDS-I-I
Order No. [2865971](#)

Digital input

MACX MCR-EX-SL-2NAM-RO
Order No. [2865476](#)

MACX MCR-SL-2NAM-RO
Order No. [2865049](#)

Digital output

MACX MCR-EX-SL-SD-24-48-LP
Order No. [2865609](#)

Power module

TC-MACX-MCR-PTB
Order No. [2904673](#)

Digital output

PSR-SCP-24DC/FSP/2X1/1X2
Order No. [2986960](#)

PSR-SCP-24DC/FSP/1X1/1X2
Order No. [2981978](#)

PSR-SCP-24DC/FSP2/2X1/1X2
Order No. [2986575](#)

PSR-SCP-24DC/ETP/1X1
Order No. [2986711](#)

PSR-SPP-24DC/ETP/1X1
Order No. [2986562](#)

PSR-PC50-1NO-1DO-24DC-SC
Order No. [2904664](#)

* For the necessary cable sets for connecting the safety relays to the Termination Carrier, visit: www.phoenixcontact.net/products

Controller-specific system cabling

Termination Carriers for Yokogawa Centum VP and ProSafe-RS

The Termination Carriers are a compact solution for connecting signal conditioners and coupling relays to the Yokogawa Centum VP and ProSafe-RS systems.

- Mechanically decoupled PCB
- Redundant system connection
- Simple or redundant supply (decoupled from diode, protected against polarity reversal) and monitoring function. Implementation via separate DIN rail module or integrated circuit on the PCB.

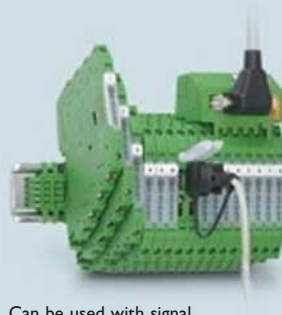

Can be used with signal conditioners from the MINI Analog series

For AAI141/AAI143 analog I/O modules
For AAI543 analog I/O modules



Can be used with Ex i signal conditioners from the MACX Analog Ex series

For ADV151/ADV161 digital I/O modules
For ADV551/ADV561 digital I/O modules
For AAI543 analog I/O modules
For AAI141/AAI143 analog I/O modules
For SDV144 digital I/O module
For SDV541 digital I/O module
For SAI143 analog I/O module
For SAI533 analog I/O module



Can be used with coupling relays from the PSR-FSP/PSR-ETP series

For SDV541 digital I/O module (low demand application)
For SDV541 digital I/O module (high demand application)



**Termination Carrier
for Centum VP
system for 16 signal
conditioners**

**Termination Carrier
for Centum VP system
for 16/32 Ex i signal
conditioners (SIL 2)**

**Termination Carrier
for ProSafe-RS system
for 8/16 Ex i signal
conditioners (SIL 2)**

**Termination Carrier
for ProSafe-RS system
for 16 PSR-FSP/PSR-
ETP relays**

TC-2KS40-A/16-M-PRH-CS
Order No. [2905257](#)

TC-2KS40-AO16-M-PRH-CS
Order No. [2905905](#)

TC-2KS50-DI32-2EX-PR-CS
Order No. [2904676](#)

TC-2KS50-DO32-EX-PR-CS
Order No. [2904676](#)

TC-2KS40-AO16-EX-PR-CS
Order No. [2905201](#)

TC-2KS40-AI16-EX-PR-CS
Order No. [2905677](#)

TC-2KS50-DI16-EX-PR-RS
Order No. [2905202](#)

TC-2KS50-DO16-EX-PR-RS
Order No. [2905678](#)

TC-2KS40-AI16-EX-PR-RS
Order No. [2905203](#)

TC-2KS40-AO8-EX-PR-RS
Order No. [2905204](#)

TC-2KS50-DO16-F&G-AR-RS
Order No. [2904112](#)

TC-2KS50-DO16-ESD-AR-RS
Order No. [2904113](#)

System cabling for ABB S 800 I/O

Select card

Digital input	
DI810 24 V DC, current sink	A, B, D
DI814 24 V DC, current source	C, E
DI830 24 V DC, current sink	A, B, D
DI840 24 V DC, current sink	A, B, D
Digital output	
DO810 24 V DC, current source, 0.5 A	A, B, E
DO814 24 V DC, current sink, 0.5 A	C, E
DO840 24 V DC, current source	A, B, E
Analog input	
AI810, AI815, AI820	D
AI830, AI835	E
Analog output	
AO810, AO815	E
AO820, AO845	D, E



	Select system cable	+ Select termination board
A	25-pos. system cable CABLE-D25SUB/B/2X14/200/TU812 Order No. 2304652 2.0 m (other lengths available) Connects 2 x 8 channels via: 1 TU 812 MTU, 1 system cable (splitting cable), 2 termination boards with byte-by-byte marking	1-conductor connection VIP-2/SC/FLK14/PLC Order No. 2315214 Without LED, screw connection VIP-2/SC/FLK14/LED/PLC Order No. 2322249 With LED, screw connection
	25-pos. system cable CABLE-D25SUB/B/2X14/200/TU812 Order No. 2304652 2.0 m (other lengths available) Connects 2 x 8 channels via: 1 TU 812 MTU, 1 system cable (splitting cable), 2 termination boards with relays or optocouplers	Relay, 1 N/O contact UMK-8RM/MR-G24/1/PLC Order No. 2979469 Output, screw connection
C	25-pos. system cable CABLE-D25SUB/B/2X14/200/TU812 Order No. 2304652 2.0 m (other lengths available) Connects 2 x 8 channels via: 1 TU 812 MTU, 1 system cable (splitting cable), 2 termination boards for negative switching I/O modules	1-conductor connection VIP-2/SC/FLK14/PLC Order No. 2315214 Screw connection
	25-pos. system cable CABLE-D25SUB/B/S/200/KONFEK/S Order No. 2302159 2.0 m (other lengths available) Connects all signals via: 1 TU 812 MTU, 1 system cable (D-SUB, pin/socket), 1 termination board with numerical marking	1-conductor connection VIP-3/SC/D25SUB/F Order No. 2315188 Screw connection
E	25-pos. system cable CABLE-D25SUB/B/S/200/KONFEK/S Order No. 2302159 2.0 m (other lengths available) Connects all signals via: 1 TU 812 MTU, 1 system cable (D-SUB, pin/socket), 1 termination board with numerical marking	1-conductor connection VIP-3/SC/D25SUB/F Order No. 2315188 Screw connection



3-conductor connection

VIP-3/SC/FLK14/8IM/PLC

Order No. [2322278](#)

Without LED, screw connection

VIP-3/SC/FLK14/8IM/LED/PLC

Order No. [2322265](#)

With LED, screw connection

Fuse

FLKM 14/8M/SI/PLC

Order No. [2294487](#)

Output, screw connection

Knife disconnection

FLKM 14/KDS 3-MT/PPA/PLC

Order No. [2290423](#)

Screw connection

3-cond. connection, knife disconnection and fuse per channel

UM-FLK14/SI/LA/PTS/8IM/PLC

Order No. [2306993](#)

Without LED, screw connection

Relay, 1 PDT

UM-8RM/RT-G24/21/PLC

Order No. [2968386](#)

Output, screw connection

Relay, 2 PDTs

UMK-8RELS/KSRG24/21-21/PLC

Order No. [2976187](#)

Output without relay, screw connection

REL-KSR-G24/21-21

Order No. [2960698](#)

Output, plug-in relay, screw connection

Relay, 1 PDT, knife disconnection

UM-8RELS/KSR-G24/21/MT/PLC

Order No. [2962463](#)

Output without relay, screw connection

REL-KSR-G24/21

Order No. [2960630](#)

Output, plug-in relay, screw connection

PLC-V8 adapter*

PLC-V8/FLK14/IN

Order No. [2296553](#)

Input, for 6.2 mm PLC relay

PLC-V8/FLK14/OUT

Order No. [2295554](#)

Output, for 6.2 mm PLC relay

PLC-V8L/FLK14/OUT

Order No. [2299660](#)

Output, for 14 mm PLC relay

3-conductor connection

VIP-3/SC/FLK14/8IM/PLC

Order No. [2322278](#)

Screw connection

Knife disconnection

FLKM 14/KDS 3-MT/PPA/PLC

Order No. [2290423](#)

Screw connection

PLC-V8 adapter* for 6.2 mm PLC relay

PLC-V8/FLK14/IN/M

Order No. [2304115](#)

Input

PLC-V8/FLK14/OUT/M

Order No. [2304102](#)

Output

PLC-V8 adapter* for 14 mm PLC relay

PLC-V8L/FLK14/OUT/M

Order No. [2304306](#)

Output

Knife disconnection and separate positive potential connections

FLKM-D25SUB/B/KDS3-MT/TU810/P

Order No. [2304539](#)

Screw connection

Knife disconnection, sep. positive and negative potential connections

FLKM-D25SUB/B/KDS3-MT/TU830

Order No. [2304526](#)

Screw connection

Knife disconnection and separate negative potential connections

FLKM-D25SUB/B/KDS3-MT/TU810

Order No. [2304513](#)

Screw connection

Knife disconnection, sep. positive and negative potential connections

FLKM-D25SUB/B/KDS3-MT/TU830

Order No. [2304526](#)

Screw connection

* The PLC-V8 adapters are simply plugged into 8 neighboring PLC relay modules.

For more system cabling components, visit www.phoenixcontact.net/abb

System cabling for Emerson

DeltaV M-series I/O
or
DeltaV S-series I/O

Select card

Digital input	
VE4001S2T1B3, SE4001S2T1B3	B, D
VE4001S2T2B3, SE4001S2T2B3	B
Series 2 Digital input card	B, C
VE4001S2T2B5, SE4001S2T2B5	E, F
Digital output	
VE4002S1T1B3, SE4002S1T1B3	B, D
VE4002S1T2B3, SE4002S1T2B3	B, C
Series 2 Digital output card	B, C
VE4002S1T2B4	A
VE4002S1T2B6, SE4002S1T2B6	E, F
Analog input	
VE4003S2B4, SE4003S2B4	B
Analog output	
VE4005S2B3, SE4005S2B3	B



	Select system cable	+ Select termination board
A	10-pos. system cable FLK 10/EZ-DR/ 200/KONFEK Order No. 2299233 2.0 m (other lengths available)	1:1 connection VIP-2/SC/FLK10/LED Order No. 2322045 With LED
	16-pos. system cable FLK 16/EZ-DR/ 200/KONFEK Order No. 2299327 2.0 m (other lengths available)	1:1 connection FLKM 16/DV Order No. 2304432 Screw connection
C	16-pos. system cable FLK 16/14/DV-OUT/200 Order No. 2300588 2.0 m (other lengths available)	Relay, 1 N/O contact UMK-8RM/MR-G24/1/PLC Order No. 2979469 Output, screw connection
	16-pos. system cable FLK 16/14/DV-IN/200 Order No. 2300562 2.0 m (other lengths available)	
E	50-pos. system cable FLK 50/2FLK20/EZ-DR/ 200/DV Order No. 2304908 2.0 m (other lengths available)	2-conductor connection (common negative potential) FLKM 50/32M/OUT/LA/DV Order No. 2304843 Output with LED, screw connection FLKM 50/32M/IN/LA/DV Order No. 2304856 Input with LED, screw connection
	20-pos. system cable FLK 20/2FLK14/EZ-DR/200/KONFEK Order No. 2298438 2.0 m (other lengths available)	Relay, 1 N/O contact UMK-8RM/MR-G24/1/PLC Order No. 2979469 Output, screw connection

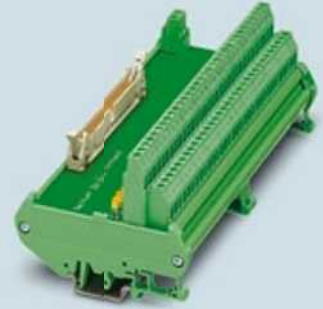

Relay, 1 PDT

UMK- 8 RM24
Order No. [2971357](#)

1:1 connection with separate potential terminal blocks

FLKM 16/AI/DV
Order No. [2304429](#)
Screw connection

Fuse

FLKM 16/AO/SI/DV
Order No. [2304445](#)
Analog output with LED, screw connection

FLKM 16/DI/SI/LA/DV
Order No. [2304458](#)
Digital input with LED, screw connection

Fuse and shield terminals

UM-DELTA V/D/SI/BFI/TP
Order No. [5603257](#)
Digital with BFI*, screw connection

Fuse, test sockets and shield terminals that can be separated

UM-DELTA V/A/SI/BFI/TP
Order No. [5603258](#)
Analog with BFI*, screw connection

Relay, 1 PDT

UMK-8RM/KSR-G24/21/PLC
Order No. [2979485](#)
Output, screw connection

PLC-V8 adapter for 6.2 mm PLC relay

PLC-V8/FLK14/IN/M
Order No. [2304115](#)
Input

PLC-V8/FLK14/OUT
Order No. [2295554](#)
Output
The PLC-V8 adapters are simply plugged into 8 neighboring PLC relay modules.

PLC-V8L adapter for 14 mm PLC relay

PLC-V8L/FLK14/OUT
Order No. [2299660](#)
Output

The PLC-V8 adapters are simply plugged into 8 neighboring PLC relay modules.

Proximity switch input (NAMUR)

UM-32 NAM/I/M/DV
Order No. [2305046](#)
Input, screw connection

Electrically isolated input (solid-state relay)

UM 320M-24DC/48DC/I/M/PLC
Order No. [2394979](#)
24 V DC input, screw connection

Relay, 1 N/O contact

UMK-32RM/MR-G24/1/PLC
Order No. [2979472](#)
Output, screw connection

Relay, 1 PDT

UMK-16RM/KSR-G24/21/PLC
Order No. [2979498](#)
Output, screw connection
UMK-16RM/KSR-G24/21/E/PLC
Order No. [2979508](#)
Extension module

Relay, 1 PDT

UMK-8RM/KSR-G24/21/PLC
Order No. [2979485](#)
Output, screw connection

PLC-V8 adapter for 6.2 mm PLC relay

PLC-V8/FLK14/IN/M
Order No. [2304115](#)
Input

PLC-V8/FLK14/OUT
Order No. [2295554](#)
Output
The PLC-V8 adapters are simply plugged into 8 neighboring PLC relay modules.

PLC-V8 adapter for 6.2 mm PLC relay

PLC-V8L/FLK14/OUT
Order No. [2299660](#)
Output

The PLC-V8 adapters are simply plugged into 8 neighboring PLC relay modules.

*Blown fuse indication

For more system cabling components, visit www.phoenixcontact.net/emerson

System cabling for Honeywell C series

Select card

Digital input	
TDIL DI-24 V, 32 channels, non-redundant	A, C
TDIL11 DI-24 V, 32 channels, redundant	A, C
Digital output	
TDOB01 DO-24 V, 32 channels, non-redundant	B, D
TDOB11 DO-24 V, 32 channels, redundant	B, D
Analog input	
TAIX01 AI, 16 channels, non-redundant	E
TAIX11 AI, 16 channels, redundant	E
Analog output	
TAOX01 AO, 16 channels, non-redundant	F
TAOX11 AO, 16 channels, redundant	F



Select adapter	+ Select system cable
A Adapter FLKM-PAD37/HW/DIO/C300 Order No. 2901423 Connects 32 channels: 2 adapters, 2 system cables, 2 termination boards	37-pos. system cable CABLE-37/SUB/B/B/.../KONFEK/S Order No. 2305512 2.0 m (other lengths available)
B Adapter FLKM-PAD37/HW/DIO/C300 Order No. 2901423 Connects 32 channels: 2 adapters, 2 system cables, 2 termination boards	37-pos. system cable CABLE-37/SUB/B/B/.../KONFEK/S Order No. 2305512 2.0 m (other lengths available)
C Adapter FLKM-PA-2D15/HW/DI/C300 Order No. 2901879 Connects 32 digital inputs: 2 adapters, 4 system cables, 4 V8 adapters, and 32 PLC relays	15-pos. system cable CABLE-D15/SUB/B/S/.../KONFEK/S Order No. 2302081 2.0 m (other lengths available)
D Adapter FLKM-PA-2D15/HW/DO/C300 Order No. 2900924 Connects 32 digital outputs: 2 adapters, 4 system cables, 4 V8 adapters, and 32 PLC relays	15-pos. system cable CABLE-D15/SUB/B/S/.../KONFEK/S Order No. 2302081 2.0 m (other lengths available)
E Adapter FLKM-PAD37/HW/AN/C300 Order No. 2900622 Connects 16 channels: 1 adapter, 1 system cable, 1 termination board	37-pos. system cable CABLE-37/SUB/B/B/.../KONFEK/S Order No. 2305512 2.0 m (other lengths available)
F Adapter FLKM-PAD37/HW/AN/C300 Order No. 2900622 Connects 16 channels: 1 adapter, 1 system cable, 1 termination board	37-pos. system cable CABLE-37/SUB/B/B/.../KONFEK/S Order No. 2305512 2.0 m (other lengths available)

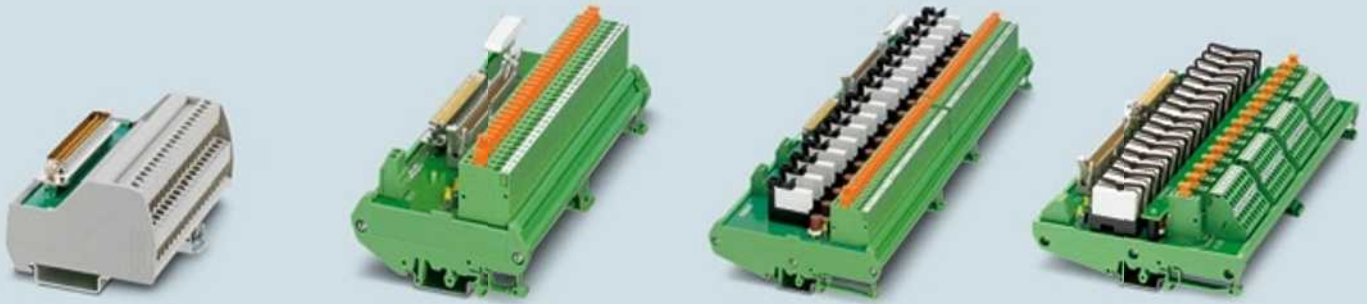

+ Select termination board

Passive, 1:1 connection
Screw connection

VIP-2/SC/D37SUB/M
Order No. [2900676](#)
VIP-2/SC/D37SUB/M/SO
Order No. [2900786](#)
Honeywell-specific markings

Passive, 1:1 connection,
knife disconnection

UM-D37SUB/M/HC3/AIO/MT
Order No. [2900067](#)
Without LED, screw connection
UM-D37SUB/M/HC3/16DI/LA/MT
Order No. [2900070](#)
LED per channel, screw connection

Relay, 1 N/O contact,
knife disconnection

UM-D37SUB/M/HC3/16DI/MR/SI/MT
Order No. [2900066](#)
Screw connection

Passive, 1:1 connection
Screw connection

VIP-2/SC/D37SUB/M
Order No. [2900676](#)
VIP-2/SC/D37SUB/M/SO
Order No. [2900786](#)
Honeywell-specific markings

Passive, 1:1 connection,
knife disconnection

UM-D37SUB/M/HC3/AIO/MT
Order No. [2900067](#)
Without LED, screw connection

Relay, 1 PDT

UM-D37SUB/M/HC3/16DO/MR/MT
Order No. [2900068](#)
Screw connection

Relay, 1 PDT

UM-D37SUB/M/HC3/16DO/MR/SI/Z
Order No. [2900190](#)
Spring-cage connection

PLC-V8 adapter for digital
inputs for 6.2 mm PLC relay*

PLC-V8/D15B/IN
Order No. [2296087](#)
Input

PLC-V8 adapter for digital
outputs for 6.2 mm PLC relay*

PLC-V8/D15B/OUT
Order No. [2296061](#)
Output

Passive, 1:1 connection
Screw connection

VIP-2/SC/D37SUB/M
Order No. [2900676](#)
VIP-2/SC/D37SUB/M/SO
Order No. [2900786](#)
Honeywell-specific markings

Passive, 1:1 connection
Screw connection

VIP-3/SC/D37SUB/M/HW/C300
Order No. [2900675](#)

Passive, 1:1 connect., spring-cage
connection and knife disconnection

UM-D37SUB/M/HC3/AI/FMT
Order No. [2900188](#)

Passive, 1:1 connection,
knife disconnection

UM-D37SUB/M/HC3/AIO/FMT
Order No. [2900189](#)
Spring-cage connection
UM-D37SUB/M/HC3/AIO/MT
Order No. [2900067](#)
Screw connection

Passive, 1:1 connect., spring-cage
connection and knife disconnection

VIP-2/SC/D37SUB/M
Order No. [2900676](#)
VIP-2/SC/D37SUB/M/SO
Order No. [2900786](#)
Honeywell-specific markings

Passive, 1:1 connect., spring-cage
connection and knife disconnection

UM-D37SUB/M/HC3/AI/FMT
Order No. [2900188](#)

Passive, 1:1 connection,
knife disconnection

UM-D37SUB/M/HC3/AIO/FMT
Order No. [2900189](#)
Spring-cage connection
UM-D37SUB/M/HC3/AIO/MT
Order No. [2900067](#)
Screw connection

* The PLC-V8 adapters are simply plugged into 8 neighboring PLC relay modules.

For more system cabling components, visit www.phoenixcontact.net/honeywell

System cabling for Siemens S7-300 and ET 200M with VARIOFACE termination boards

Select card

I/O cards	
6ES7 321-1BH02-0AA0	C, D
6ES7 321-1BH10-0AA0	C, D
6ES7 321-1BH50-0AA0*	D
6ES7 321-1BL00-0AA0	A, B, E
6ES7 321-7BH01-0AB0*	D
6ES7 322-1BH01-0AA0	C, D
6ES7 322-1BH10-0AA0	C, D
6ES7 322-1BL00-0AA0	A, B, E
6ES7 322-8BF00-0AB0*	D
6ES7 323-1BH01-0AA0	C, D
6ES7 323-1BL00-0AA0	A, B, E
6ES7 331-1KF01-0AB0*	E
6ES7 331-7HF01-0AB0*	D
6ES7 331-7KB02-0AB0*	D
6ES7 331-7KF02-0AB0*	D
6ES7 331-7PF01-0AB0*	E
6ES7 331-7PF11-0AB0*	E
6ES7 331-7NF00-0AB0*	E
6ES7 331-7NF10-0AB0*	E
6ES7 331-7TF01-0AB0*	D
6ES7 332-5HD01-0AB0*	D
6ES7 332-5HB01-0AB0*	D
6ES7 332-5HF00-0AB0*	E
6ES7 332-7ND02-0AB0*	D
6ES7 334-0CE01-0AA0*	D
6ES7 334-0KE00-0AB0*	D
6ES7 335-7HG01-0AB0*	D
6ES7 338-4BC01-0AB0*	D
6ES7 350-1AH03-0AE0*	D
6ES7 350-2AH01-0AE0*	E
6ES7 351-1AH01-0AE0*	D
6ES7 352-1AH02-0AE0*	D
6ES7 353-1AH01-0AE0*	D
6ES7 354-1AH01-0AE0*	D
6ES7 355-0VH10-0AE0*	D
6ES7 355-1VH10-0AE0*	D
6ES7 357-4AH01-0AE0*	E

* All bridges on the adapter must be removed.



Select front adapter

	S7-300	Front adapter
A	Connects 1 x 32 channels: • 1 front adapter with connected system cable • 1 termination board with byte-by-byte marking	VIP-PA-FLK50/.../S7 Order No. 2321800 2.0 m (other lengths available)
	Connects 4 x 8 channels: • 1 front adapter with four connected system cables • 4 termination boards with byte-by-byte marking	VIP-PA-FLK50/4X14/.../S7 Order No. 2321910 2.0 m (other lengths available)
C	Modules with 20-pos. connection: • 1 front adapter with four connected system cables • 2 termination boards with byte-by-byte marking	VIP-PA-FLK14/.../S7 Order No. 2321790 2.0 m (other lengths available)
	Modules with 20-pos. connection: • 1 front adapter with two connected system cables • 1 termination board with numerical marking (1 - 20)	VIP-PA-FLK14/.../S7 Order No. 2321790 2.0 m (other lengths available)
E	Modules with 40-pos. connection: • 1 front adapter with connected system cable • 1 termination board with numerical marking (1 - 40)	VIP-PA-FLK50/.../S7 Order No. 2321800 2.0 m (other lengths available)

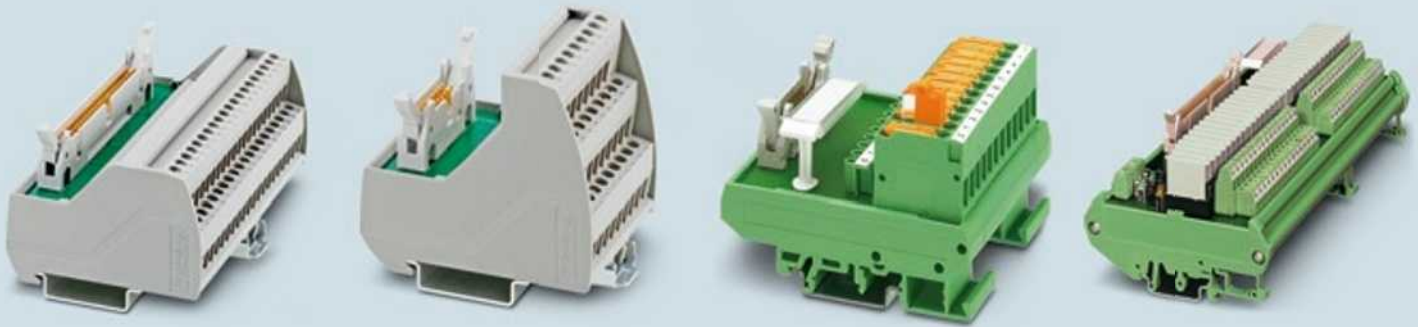

+ Select termination board

Passive, 1-conductor connection, screw connection

VIP-2/SC/FLK50/PLC

Order No. [2315227](#)

Without LED

VIP-2/SC/FLK50/LED/PLC

Order No. [2322252](#)

With LED

Passive, 3-cond. connection with common positive/negative potential

UM 45-FLK 50/32IM/PLC

Order No. [2962890](#)

Screw connection

FLKMS 50/32IM/ZFKDS/PLC

Order No. [2901389](#)

Spring-cage connection

Passive, 1-conductor connection, knife disconnection

FLKM 50/KDS 3-MT/PPA/PLC

Order No. [2290614](#)

Screw connection

Relay, screw connection

UMK-32RM/MR-G24/1/PLC

Order No. [2979472](#)

1 N/O contact

UM-32RM/RT-G24/21/PLC

Order No. [2968373](#)

1 PDT

Passive, 1-conductor connection, screw connection

VIP-2/SC/FLK14/PLC

Order No. [2315214](#)

Without LED

VIP-2/SC/FLK14/LED/PLC

Order No. [2322249](#)

With LED

Passive, 3-cond. connection with common positive/negative potential

VIP-3/SC/FLK14/8IM/PLC

Order No. [2322278](#)

Without LED, screw connection

VIP-3/SC/FLK14/8IM/LED/PLC

Order No. [2322265](#)

With LED, screw connection

Passive, 1-conductor connection, knife disconnection

FLKM 14/KDS 3-MT/PPA/PLC

Order No. [2290423](#)

Screw connection

PLC-V8 adapter*

PLC-V8/FLK14/IN

Order No. [2296553](#)

Input, for 6.2 mm PLC relay

PLC-V8/FLK14/OUT

Order No. [2295554](#)

Output, for 6.2 mm PLC relay

PLC-V8L/FLK14/OUT

Order No. [2299660](#)

Output, for 14 mm PLC relay

Passive, 1-conductor connection, screw connection

VIP-2/SC/FLK14/PLC

Order No. [2315214](#)

Without LED

VIP-2/SC/FLK14/LED/PLC

Order No. [2322249](#)

With LED

Passive, 3-cond. connection with common positive/negative potential

VIP-3/SC/FLK14/8IM/PLC

Order No. [2322278](#)

Without LED, screw connection

VIP-3/SC/FLK14/8IM/LED/PLC

Order No. [2322265](#)

With LED, screw connection

Passive, 1-conductor connection, knife disconnection

FLKM 14/KDS 3-MT/PPA/PLC

Order No. [2290423](#)

Screw connection

PLC-V8 adapter*

PLC-V8/FLK14/IN

Order No. [2296553](#)

Input, for 6.2 mm PLC relay

PLC-V8/FLK14/OUT

Order No. [2295554](#)

Output, for 6.2 mm PLC relay

PLC-V8L/FLK14/OUT

Order No. [2299660](#)

Output, for 14 mm PLC relay

Passive, 1-conductor connection, screw connection

VIP-2/SC/2FLK14(1-20)/S7

Order No. [2315230](#)

Without LED

Passive, 1-conductor connection with spring-cage connection

UM 45-2FLK 14/ZFKDS/S7

Order No. [2965156](#)

Without LED

Passive, 1-conductor connection, knife disconnection

FLKM-2FLK14/KDS3-MT/PPA/S7

Order No. [2295062](#)

Screw connection

Passive, 1-conductor connection, screw connection

VIP-2/SC/FLK50(1-40)/S7

Order No. [2315243](#)

Without LED

Passive, 1-conductor connection with spring-cage connection

UM 45-FLK 50/ZFKDS/S7-300

Order No. [2968111](#)

Without LED

Passive, 1-conductor connection, knife disconnection

FLKM 50/KDS 3-MT/PPA/S7-300

Order No. [2304490](#)

Screw connection

* The PLC-V8 adapters are simply plugged into 8 neighboring PLC relay modules.

For more system cabling components, visit www.phoenixcontact.net/products

Example combinations

Front adapter with open cable end



SIMATIC S7-300 controller

Select front adapter

A

Connection of 40-pos. modules via 40 individual wires in rope structure (unassembled).

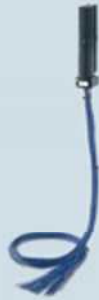

Front adapter

- 1.0 m **VIP-PA-PWR/40XOE/ 1,0M/S7**
Order No. [2904731](#)
- 2.0 m **VIP-PA-PWR/40XOE/ 2,0M/S7**
Order No. [2904732](#)
- 3.0 m **VIP-PA-PWR/40XOE/ 3,0M/S7**
Order No. [2904733](#)
- ...
- 10.0 m **VIP-PA-PWR/40XOE/10,0M/S7**
Order No. [2904737](#)

B

Connection of 20-pos. modules via 20 individual wires in rope structure (unassembled).



Front adapter

- 1.0 m **VIP-PA-PWR/20XOE/ 1,0M/S7**
Order No. [2904724](#)
- 2.0 m **VIP-PA-PWR/20XOE/ 2,0M/S7**
Order No. [2904725](#)
- 3.0 m **VIP-PA-PWR/20XOE/ 3,0M/S7**
Order No. [2904726](#)
- ...
- 10.0 m **VIP-PA-PWR/20XOE/10,0M/S7**
Order No. [2904730](#)

Terminal blocks



Feed-through terminal block

- UT 2,5**
Order No. [3044076](#)
- PT 1,5/S**
Order No. [3208100](#)
- PT 2,5**
Order No. [3209510](#)
- ST 1,5**
Order No. [3031076](#)
- ST 2,5**
Order No. [3031212](#)
- QTC 1,5**
Order No. [3205019](#)
- QTC 2,5**
Order No. [3206416](#)

- UT 2,5**
Order No. [3044076](#)
- PT 1,5/S**
Order No. [3208100](#)
- PT 2,5**
Order No. [3209510](#)
- ST 1,5**
Order No. [3031076](#)
- ST 2,5**
Order No. [3031212](#)
- QTC 1,5**
Order No. [3205019](#)
- QTC 2,5**
Order No. [3206416](#)

For more versions, possible









Corresponding accessories

Benefit from our comprehensive range of accessories. Refer to the following main catalogs:

- Catalog: Terminal blocks
- Catalog: Marking systems, tools, and mounting material

You can plug the front adapter into all common S7-300 modules according to the number of positions and secure it to the module using the snap-on mechanism (20-pos.) or mounting screw (40-pos.). The controller signals are jumpered to a 20 or 40-pos. cable with open cable end, which can be connected to terminal blocks or other connections on the field side. A selection of appropriate terminal blocks can be found in the table.

			Connection technology			
Double-level terminal block	Feed-through terminal block, 3 connections	Knife disconnect terminal block	Screw	Push-in	Spring-cage	IDC (insulation displ. contact)
						
UTT 2,5 Order No. 3044636 PTTB 1,5/S Order No. 3208511 PTTB 2,5 Order No. 3210567 STTB 1,5 Order No. 3031157 STTB 2,5 Order No. 3031270 QTTCB 1,5 Order No. 3205116	UT 2,5-TWIN Order No. 3044513 PT 1,5/S-TWIN Order No. 3208155 PT 2,5-TWIN Order No. 3209549 ST 1,5-TWIN Order No. 3031128 ST 2,5-TWIN Order No. 3031241 QTC 1,5-TWIN Order No. 3205048 QTC 2,5-TWIN Order No. 3206445	UT 2,5-MT Order No. 3046362 PT 2,5-MT Order No. 3210156 ST 2,5-MT Order No. 3036343 QTC 1,5-MT Order No. 3205103 QTC 2,5-MT Order No. 3206487	•	•	•	•
UTT 2,5 Order No. 3044636 PTTB 1,5/S Order No. 3208511 PTTB 2,5 Order No. 3210567 STTB 1,5 Order No. 3031157 STTB 2,5 Order No. 3031270 QTTCB 1,5 Order No. 3205116	UT 2,5-TWIN Order No. 3044513 PT 1,5/S-TWIN Order No. 3208155 PT 2,5-TWIN Order No. 3209549 ST 1,5-TWIN Order No. 3031128 ST 2,5-TWIN Order No. 3031241 QTC 1,5-TWIN Order No. 3205048 QTC 2,5-TWIN Order No. 3206445	UT 2,5-MT Order No. 3046362 PT 2,5-MT Order No. 3210156 ST 2,5-MT Order No. 3036343 QTC 1,5-MT Order No. 3205103 QTC 2,5-MT Order No. 3206487	•	•	•	•

For more combinations, and accessories, visit www.phoenixcontact.net/products

System cabling meets terminal block

For all common signal forms up to 250 V AC/DC, 6 A. Selection guide for front adapter and corresponding terminal block.



Terminal blocks



SIMATIC SJ-300 controller

Select front adapter

A

Connection of 40-pos. modules via four cables, each with a 10-pos. COMBI connector.

5.2 mm pitch



Front adapter

0.5 m	VIP-PA-PWR/4X10COMBI/0,5M/S7	Order No. 2904702
1.0 m	VIP-PA-PWR/4X10COMBI/ 1,0M/S7	Order No. 2904703
1.5 m	VIP-PA-PWR/4X10COMBI/ 1,5M/S7	Order No. 2904704
2.0 m	VIP-PA-PWR/4X10COMBI/2,0M/S7	Order No. 2904705
2.5 m	VIP-PA-PWR/4X10COMBI/2,5M/S7	Order No. 2904706
3.5 m	VIP-PA-PWR/4X10COMBI/3,0M/S7	Order No. 2904707
...		
10.0 m	VIP-PA-PWR/4X10COMBI/ 10,0M/S7	Order No. 2904712

Feed-through terminal block

UT 2,5/1P
Order No. 3045017

PT 2,5/1P
Order No. 3210033

ST 2,5/1P
Order No. 3040012

QTC 1,5/1P
Order No. 3050073

B

Connection of 20-pos. modules via two cables, each with a 10-pos. COMBI connector.

5.2 mm pitch



Front adapter

0.5 m	VIP-PA-PWR/2X10COMBI/0,5M/S7	Order No. 2904713
1.0 m	VIP-PA-PWR/2X10COMBI/ 1,0M/S7	Order No. 2904714
1.5 m	VIP-PA-PWR/2X10COMBI/ 1,5M/S7	Order No. 2904715
2.0 m	VIP-PA-PWR/2X10COMBI/2,0M/S7	Order No. 2904716
2.5 m	VIP-PA-PWR/2X10COMBI/2,5M/S7	Order No. 2904717
3.5 m	VIP-PA-PWR/2X10COMBI/3,0M/S7	Order No. 2904718
...		
10.0 m	VIP-PA-PWR/2X10COMBI/ 10,0M/S7	Order No. 2904723

UT 2,5/1P
Order No. 3045017

PT 2,5/1P
Order No. 3210033

ST 2,5/1P
Order No. 3040012

QTC 1,5/1P
Order No. 3050073

C

Connection of 40-pos. modules via four cables, each with a 10-pos. COMBI connector.

Reduced overall width

3.5 mm pitch



Front adapter

0.5 m	VIP-PA-PWR/4X10 PT/0,5M/S7	Order No. 2905516
1.0 m	VIP-PA-PWR/4X10 PT/ 1,0M/S7	Order No. 2905517
1.5 m	VIP-PA-PWR/4X10 PT/ 1,5M/S7	Order No. 2905518
2.0 m	VIP-PA-PWR/4X10 PT/2,0M/S7	Order No. 2905519
2.5 m	VIP-PA-PWR/4X10 PT/2,5M/S7	Order No. 2905520
3.5 m	VIP-PA-PWR/4X10 PT/3,0M/S7	Order No. 2905521
...		
10.0 m	VIP-PA-PWR/2X10COMBI/ 10,0M/S7	Order No. 2905526

PT 1,5/S/1P
Order No. 3208582

D

Connection of 20-pos. modules via two cables, each with a 10-pos. COMBI connector.

Reduced overall width

3.5 mm pitch



Front adapter

0.5 m	VIP-PA-PWR/2X10 PT/0,5M/S7	Order No. 2905528
1.0 m	VIP-PA-PWR/2X10 PT/ 1,0M/S7	Order No. 2905529
1.5 m	VIP-PA-PWR/2X10 PT/ 1,5M/S7	Order No. 2905531
2.0 m	VIP-PA-PWR/2X10 PT/2,0M/S7	Order No. 2905532
2.5 m	VIP-PA-PWR/2X10 PT/2,5M/S7	Order No. 2905533
3.5 m	VIP-PA-PWR/2X10 PT/3,0M/S7	Order No. 2905534
...		
10.0 m	VIP-PA-PWR/2X10 PT/ 10,0M/S7	Order No. 2905539

PT 1,5/S/1P
Order No. 3208582

You can plug the front adapter into all common S7-300 modules according to the number of positions and secure it to the module using the snap-on mechanism (20-pos.) or mounting screw (40-pos.). Then plug the COMBI connectors into the appropriate terminal blocks. The COMBI connectors are marked from 1 to 20 or from 1 to 40, thereby enabling clear signal assignment. A selection of appropriate terminal blocks can be found in the table.

Connection technology



Double-level terminal block

Feed-through terminal block, 3 connections

Knife disconnect terminal block

Screw

Push-in

Spring-cage

IDC (insulation displacement contact)

UTT 2,5/2P
Order No. 3060351

PTTB 2,5/2P
Order No. 3210871

STTB 2,5/2P
Order No. 3040054

QTTCB 1,5/2P
Order No. 3050196

UT 2,5-TWIN/1P
Order No. 3060490

PT 2,5-TWIN/1P
Order No. 3209633

ST 2,5-TWIN/1P
Order No. 3042117

ST 2,5-TWIN-MT/1P
Order No. 3040766

ST 2,5-TWIN-TG/1P
Order No. 3040847

UTT 2,5/2P
Order No. 3060351

PTTB 2,5/2P
Order No. 3210871

STTB 2,5/2P
Order No. 3040054

QTTCB 1,5/2P
Order No. 3050196

UT 2,5-TWIN/1P
Order No. 3060490

PT 2,5-TWIN/1P
Order No. 3209633

ST 2,5-TWIN/1P
Order No. 3042117

ST 2,5-TWIN-MT/1P
Order No. 3040766

ST 2,5-TWIN-G/1P
Order No. 3040847

PTTB 1,5/S/2P
Order No. 3212439

PT 1,5/S-TWIN/1P
Order No. 3212358

PTTB 1,5/S/2P
Order No. 3212439

PT 1,5/S-TWIN/1P
Order No. 3212358

For more versions, possible combinations, and accessories, visit www.phoenixcontact.net/products

System cabling for Yokogawa Centum VP

or

Stardom I/O

Select card

Digital input	
ADV 151	A, D
NFDV 151	A, D
ADV 161	B, E
NFDV 161	B, E

Digital output	
ADV 551	A, D
NFDV 551	A, D
ADV 561	B, E
NFDV 561	B, E

Analog input	
AAI 135	C
AAI 141	C
NFAI 141	C
NFAI 413	C
AAI 143	C
AAR 181	C
AAT 141	C
AAV 141	C
AAV 142	C

Analog output	
AAB 841	C
AAI 543	C
NFAI 543	C
AAI 835	C
AAV 542	C

* The PLC-V8 adapters are simply plugged into 8 neighboring PLC relay modules.



Select system cable		
A	<p>System cable, YUC 50</p> <p>Connects 32 channels:</p> <ul style="list-style-type: none"> • 1 YUC50 system cable • 1 termination board 	<p>FLK 50-PA/EZ-DR/KS/.../YUC Order No. 2314299 2.0 m (other lengths available)</p> <p>Halogen-free version: FLK 50-PA/EZ-DR/KS/.../YUC Order No. 2904740 2.0 m (other lengths available)</p>
	<p>System cable, 50-pos.</p> <p>Connects 64 channels:</p> <ul style="list-style-type: none"> • 2 system cables • 2 termination boards 	<p>FLK-MIL-50/EZ-DR/KS/.../YCS Order No. 2314590 2.0 m (other lengths available)</p>
C	<p>System cable, YUC 40</p> <p>Connects analog I/O cards:</p> <ul style="list-style-type: none"> • 1 YUC40 system cable • 1 termination board 	<p>FLK 40-PA/EZ-DR/KS/.../YUC Order No. 2314341 2.0 m (other lengths available)</p> <p>Halogen-free version: FLK 50-PA/EZ-DR/KS/.../YUC Order No. 2904740 2.0 m (other lengths available)</p>
	<p>System cable, YUC 50/4 x 14</p> <p>Connects 32 channels:</p> <ul style="list-style-type: none"> • 1 system cable (splitting cable) • 4 termination boards 	<p>CABLE-50/4FLK14/.../YUC Order No. 2314655 2.0 m (other lengths available)</p>
E	<p>System cable, 50 / 4 x 14</p> <p>Connects 64 channels:</p> <ul style="list-style-type: none"> • 2 system cables (splitting cables) • 8 termination boards 	<p>FLKMIL-50/4FLK14/EZ-DR/.../CS Order No. 2306304 2.0 m (other lengths available)</p>



+ Select termination board

Passive, 3-conductor connection, screw connection

FLKMS-KS50/32IM/YCS
Order No. [2314451](#)
Input/output

3-conductor connection, fuse per channel

FLKM-KS50/SI/YCS
Order No. [2314464](#)
Input/output

Relay, 1 N/O contact

UMK-32 RM/MR-G24/1/YCS
Order No. [2969055](#)
Output
UM-KS50/32-MR/21/ADV151/SO207
Order No. [2311111](#)
Input
UM-KS50/32-MR/21/ADV551/SO207
Order No. [2311108](#)
Output

NAMUR, screw connection

UM-32NAM/II/MYCS
Order No. [2968506](#)
Input, redundant I/O connection, sensor cables checked for short circuit and cable break

Passive, 3-conductor connection, screw connection

FLKMS-KS50/32IM/YCS
Order No. [2314451](#)
Input/output

Passive, 3-conductor connection, 1:1 connection

FLKM-KS50/SI/YCS
Order No. [2314464](#)
Input/output

Relay, 1 N/O contact

UMK-32 RM/MR-G24/1/YCS
Order No. [2969055](#)
Output
UM-KS50/32-MR/21/ADV151/SO207
Order No. [2311111](#)
Input
UM-KS50/32-MR/21/ADV551/SO207
Order No. [2311108](#)
Output

NAMUR, screw connection

UM-32NAM/II/MYCS
Order No. [2968506](#)
Input, redundant I/O connection, sensor cables checked for short circuit and cable break

Passive, 1:1 connection, screw connection

FLKM-KS40/YCS
Order No. [2314642](#)
Input/output

Passive, 1:1 connection, spring-cage connection

FLKM-2KS40/YCS/ZFKDS
Order No. [2314752](#)
Input/output, redundant I/O connection

Passive, 1:1 connection with common negative potential

FLKM-KS40/AO16/YCS
Order No. [2314260](#)
AAI 543 output, redundant I/O connection, HART

Passive, 1:1 connection with common negative potential

FLKMS-KS40/AI/YCS
Order No. [2314286](#)
AAI141/AA143 input, redundant I/O connection and power supply, HART

Passive, 1-conductor connection, screw connection

VIP-2/SC/FLK14/PLC
Order No. [2315214](#)
Without LED

VIP-2/SC/FLK14/LED/PLC
Order No. [2322249](#)
With LED

Passive, 3-conductor connection with common +/- potential

VIP-3/SC/FLK14/8IM/PLC
Order No. [2322278](#)
Without LED, screw connection

VIP-3/SC/FLK14/8IM/LED/PLC
Order No. [2322265](#)
With LED, screw connection

Passive, 1-conductor connection, knife disconnection

FLKM 14/KDS 3-MT/PPA/PLC
Order No. [2290423](#)
Screw connection

PLC-V8 adapter*

PLC-V8/FLK14/IN
Order No. [2296553](#)
Input, for 6.2 mm PLC relay

PLC-V8/FLK14/OUT/M
Order No. [2304102](#)
Output, for 6.2 mm PLC relay

Passive, 1-conductor connection, screw connection

VIP-2/SC/FLK14/PLC
Order No. [2315214](#)
Without LED

VIP-2/SC/FLK14/LED/PLC
Order No. [2322249](#)
With LED

Passive, 3-conductor connection with common +/- potential

VIP-3/SC/FLK14/8IM/PLC
Order No. [2322278](#)
Without LED, screw connection

VIP-3/SC/FLK14/8IM/LED/PLC
Order No. [2322265](#)
With LED, screw connection

Passive, 1-conductor connection, knife disconnection

FLKM 14/KDS 3-MT/PPA/PLC
Order No. [2290423](#)
Screw connection

PLC-V8 adapter*

PLC-V8/FLK14/IN
Order No. [2296553](#)
Input, for 6.2 mm PLC relay

PLC-V8/FLK14/OUT/M
Order No. [2304102](#)
Output, for 6.2 mm PLC relay

For more system cabling components, visit www.phoenixcontact.net/yokogawa

Universal field wiring

Automation devices provide high-position connectors or single wire connections for connecting field signals. Numerous termination boards and pre-assembled system cables are available for connecting the signals in a clear and orderly way. Various conductor cross sections and connectors are available, depending on the requirements of the signal to be transmitted and the ambient conditions.

Cables with an open end at one end can be used to connect any control unit.

Note:

The 2 m version is specified as an example for all cables. Other lengths are available.

Signal transmission with IDC/FLK connector

- Encapsulated connectors
- 0.14 mm² conductor cross section

The system cables shown are also available in a non-encapsulated version.

Technical data:

Maximum permissible operating voltage:
< 50 V AC/60 V DC

Maximum permissible current carrying capacity per path: 1 A



Select system cable	+ Select termination board	
System cable with one open end	System cable with socket strip at both ends	Modules with pin strip
VIP-CAB-FLK14/FR/OE/0,14/2,0M Order No. 2900126 14-pos. (2.0 m)	VIP-CAB-FLK14/0,14/2,0M Order No. 2318415 14-pos. (2.0 m)	VIP-2/SC/FLK14 Order No. 2315023 14-pos.
VIP-CAB-FLK16/FR/OE/0,14/2,0M Order No. 2900133 16-pos. (2.0 m)	VIP-CAB-FLK16/0,14/2,0M Order No. 2318499 16-pos. (2.0 m)	VIP-2/SC/FLK16 Order No. 2315036 16-pos.
VIP-CAB-FLK20/FR/OE/0,14/2,0M Order No. 2900142 20-pos. (2.0 m)	VIP-CAB-FLK20/0,14/2,0M Order No. 2318570 20-pos. (2.0 m)	VIP-2/SC/FLK20 Order No. 2315049 20-pos.
VIP-CAB-FLK50/FR/OE/0,14/2,0M Order No. 2900149 50-pos. (2.0 m)	VIP-CAB-FLK50/0,14/2,0M Order No. 2318897 50-pos. (2.0 m)	VIP-3/SC/FLK50 Order No. 2315081 50-pos.

For more system cabling components, visit www.phoenixcontact.net/products

Signal transmission with ELCO/EDAC connectors

- Robust metal shell housing
- Codable connector
- 0.34 mm² conductor cross section
- Shielded system cable

Technical data:

Maximum permissible operating voltage: 25 V AC/60 V DC

Maximum permissible current carrying capacity per path: 1.5 A



Select system cable	+ Select termination board
System cable with one open end CABLE-EC56/F/OE/0,34/S/2,0M Order No. 2903396 56-pos. (2.0 m)	Modules with pin strip UMK- EC56/56-XOR Order No. 2975900 56-pos.

For more system cabling components, visit www.phoenixcontact.net/products

Signal transmission with D-SUB connectors

- Housing screw connection: UNC-4-40 screws
- 0.25 mm² conductor cross section
- Shielded system cable

Technical data:

Maximum permissible operating voltage: 125 V AC/DC

Maximum permissible current carrying capacity per path: 2 A



Select system cable	+ Select termination board	
System cable with one open end CABLE-D- 9SUB/F/OE/0,25/S/2,0M Order No. 2926043 9-pos. (2.0 m)	System cable with pin and socket strip CABLE-D 9SUB/B/S/200/KONFEK/S Order No. 2302010 9-pos. (2.0 m)	Modules with pin strip VIP-2/SC/D 9SUB/M Order No. 2315117 9-pos.
CABLE-D-15SUB/F/OE/0,25/S/2,0M Order No. 2926111 15-pos. (2.0 m)	CABLE-D15SUB/B/S/200/KONFEK/S Order No. 2302081 15-pos. (2.0 m)	VIP-2/SC/D15SUB/M Order No. 2315120 15-pos.
CABLE-D-25SUB/F/OE/0,25/S/2,0M Order No. 2926182 25-pos. (2.0 m)	CABLE-D25SUB/B/S/200/KONFEK/S Order No. 2302159 25-pos. (2.0 m)	VIP-3/SC/D25SUB/M Order No. 2315133 25-pos.
CABLE-D-37SUB/F/OE/0,25/S/2,0M Order No. 2926250 37-pos. (2.0 m)	CABLE-D37SUB/B/S/200/KONFEK/S Order No. 2302227 37-pos. (2.0 m)	VIP-3/SC/D37SUB/M Order No. 2315146 37-pos.
CABLE-D-50SUB/F/OE/0,25/S/2,0M Order No. 2926328 50-pos. (2.0 m)	CABLE-D50SUB/B/S/200/KONFEK/S Order No. 2302298 50-pos. (2.0 m)	VIP-3/SC/D50SUB/M Order No. 2315159 50-pos.

For more system cabling components, visit www.phoenixcontact.net/products

Process Fieldbus

Genuine modularity in a fieldbus

The modular fieldbus components in the FB... product range enable communication from the process controller to the field devices for FOUNDATION Fieldbus or PROFIBUS PA applications. The electrically isolated fieldbus power supplies provide power while enabling communication with one segment. The device couplers in the pre-assembled field junction boxes connect the devices and ensure that segments are protected. Combined with redundant DC power supplies and surge protection, a complete connection architecture is provided.

Your advantages at a glance

Increase the availability of your processes with single-channel fieldbus barriers and redundant power supplies. In addition, save time and costs thanks to tailored installation, minimal planning effort, quick module replacement, and flexible expansion.

For more information, visit our website at:

www.phoenixcontact.net/processfieldbus



Fieldbus components

PROFIBUS DP/PA interface

The modular PROFIBUS interface enables transparent communication between PROFIBUS PA field devices and a higher-level PROFIBUS DP fieldbus and can be extended to ten segments. The web server in the head station supports configuration via DTM and remote diagnostics for the network and all connected field devices.



Fieldbus and DC power supplies

The FOUNDATION Fieldbus power supplies from Phoenix Contact enable the modular integration of DCS systems in FOUNDATION Fieldbus H1. Both simple and redundant power supplies are available for superior system availability, with an output current of up to 500 mA at 28 V.



Device couplers and trunk line modules

The modular fieldbus device couplers from Phoenix Contact establish an infrastructure connection between the process fieldbus controller and the field devices. They provide short-circuit protection and limit energy. The power supply and communication are routed via modular DIN rail connectors installed on the DIN rail. This enables replacement and expansion during operation.



Solutions for the fieldbus power supply

A high-availability power supply is required for the safe and reliable operation of a FOUNDATION Fieldbus H1 segment. Phoenix Contact offers simple and redundant fieldbus power supplies for this.

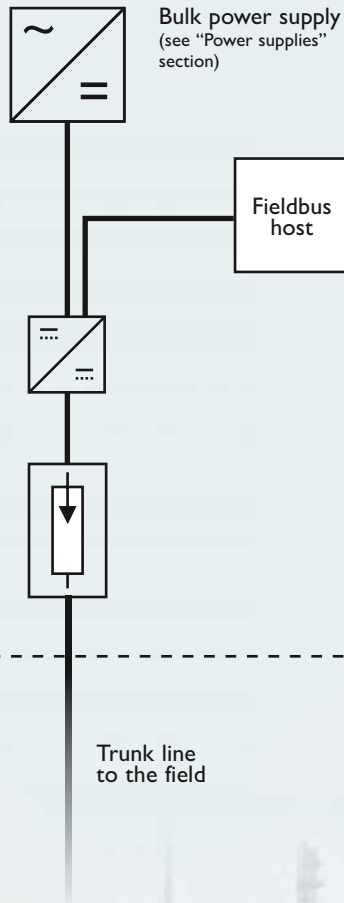

Technical data

- Approvals
- Input voltage range
- Output voltage range
- Output current
- One-piece/multipartite
- Nominal voltage range

Description



PROFIBUS DP/PA interface

FB-HSB-DP/PA
Order No. [2316370](#)

Accessories:

FB-DP-RPTR/SC
Order No. [2316374](#)

FB-DP-RPTR
Order No. [2316373](#)

FB-PA/SC
Order No. [2316375](#)



Fieldbus power supply

FB-PS-25/0.36A
Order No. [2316035](#)

ME 22,5 TBUS 1,5/ 5-ST- 3,81 GN
Order No. [2707437](#)

ATEX
19.2 V DC ... 35 V DC
25 V DC ... 27 V DC
360 mA
–
–



Redundant fieldbus power supply

FB-PS-BASE/EX
Order No. [2316145](#)

FB-PS-PLUG-24DC/28DC/0.5/EX
Order No. [2316132](#)

D-FB-PS
Order No. [2316226](#)

ZEC 1,5/ 4-LPV-5,0 C2,4 BK
Order No. [1793260](#)

ZEC 1,0/ 6-LPV-3,5 C1
Order No. [1915699](#)

UC-TM 16
Order No. [0819217](#)

UC-TMF 16
Order No. [0819262](#)

IECEX, ATEX
18.5 V DC ... 30.5 V DC
27 V DC ... 30 V DC
500 mA
–
–



Power supply unit for redundant four-channel fieldbus power supply

FB-PS-MB-Y/EX
Order No. [2316148](#)

FB-PS-MB-I/EX
Order No. [2316149](#)

FB-PS-MB-25DSUB/EX
Order No. [2316146](#)

Accessories:

FB-PS-PLUG-24DC/28DC/0.5/EX
Order No. [2316132](#)

ATEX
–
–
Max. 1.6 A
Multipartite, plug-in
32 V DC

The FB-HSB-DP/PA coupler transparently converts PROFIBUS DP to PROFIBUS PA while providing detailed network diagnostics.

- Up to ten individual PROFIBUS DP or PROFIBUS PA modules per head station
- Powerful embedded web server for configuration and access to network diagnostics
- PROFIBUS PA connection automatically and transparently detects any baud rate up to 12 Mbps
- Management and configuration of PROFIBUS field devices using FDT/DTM

For the high-power trunk installation, an FB-PS-BASE/EX base module with two FB-PS-PLUG plug-in power supplies supplies one segment with the necessary power of 500 mA at 28 V DC.

The base modules can be aligned, thereby reducing wiring effort. The FB-PS-PLUG plug-in power supplies ensure high availability. The power is automatically divided equally between both plug-in power supplies, thereby increasing the service life. The basic diagnostics of a segment are performed via the integrated relay signal contact.

Solutions for the fieldbus

Phoenix Contact offers a complete solution for your fieldbus application, consisting of trunk line modules, device couplers, pre-assembled cables, appropriate surge protection, and ready-mounted field junction boxes that can be assembled according to your specific requirements.

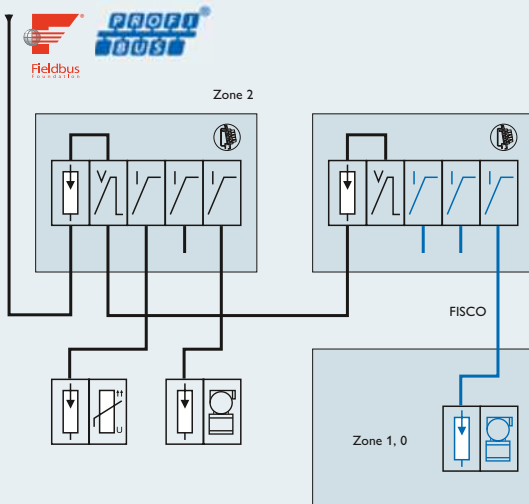

Diagnostics for FOUNDATION Fieldbus in the field

The field diagnostics module can be used to check the signal quality of the fieldbus directly in the field in environments that are potentially susceptible to interference. The diagnostics enable preventive measures to be taken to ensure optimum device availability and prevent the sudden loss of communication between the devices.

Integration in the control level is via standard H1 communication and device management using DD (Device Description), EDDL (Electronic Device Description Language), and DTM (Device Type Manager). Due to use in the field, the measurements are not affected by long cable paths. The data is transmitted back to the control room in realtime, where it can be evaluated directly by the system operator. This means that no maintenance authorizations or process interruptions are required.

All surge protection products listed in the “Conventional signal connection to process control systems” section (page 52) are suitable for effective surge protection. For more products, visit phoenixcontact.net/products.

Technical data

Approvals

Housing material

Degree of protection

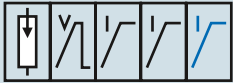

Field connection boxes and installation accessories

- FB-16 SS**
Order No. [2316417](#)
- FB-10SS**
Order No. [2316420](#)
- FB-16-SS-BLOCK**
Order No. [2316433](#)
- FB-10-SS-BLOCK**
Order No. [2316446](#)



Field diagnostics module and device coupler for FOUNDATION Fieldbus

- FB-DIAG/FF/LI**
Order No. [2316284](#)
- FB-DIAG/FF/NC**
Order No. [2316297](#)



Device couplers and trunk line modules

- FB-ET***
Order No. [2316048](#) Trunk module
- FB-2SP****
Order No. [2316051](#) Coupler for 2 devices
- FB-ISO*****
Order No. [2316064](#) FISCO device coupler
- FB-6SP**
Order No. [2316307](#)
- FB-12SP**
Order No. [2316310](#)
- FB-ET/E**
Order No. [2316050](#)
- FB-2SP/E**
Order No. [2316052](#)
- FB-2SP/24DC**
Order No. [2316352](#)



Open and pre-assembled connecting cables

- SAC-4P-MINMS/2,0-960 VAL**
Order No. [1429350](#)
- SAC-4P-2,0-960/MINFS VAL**
Order No. [1429712](#)
- SAC-4P-MINMS/0,3-960/MINFSVAL**
Order No. [1429538](#)
- SAC-4P-MINMS/2,0-961 VAL**
Order No. [1433964](#)
- SAC-4P-2,0-961/MINFS VAL**
Order No. [1433786](#)
- SAC-4P-MINMS/0,3-961/MINFSVAL**
Order No. [1434141](#)
- SAC-4P-MINMR/0,3-961/MINFSVAL**
Order No. [1434264](#)
- SAC-4P-MIN-T/2XMIN FF VA**
Order No. [1430035](#)
- SAC-4P-MINMS FF-TR VA**
Order No. [1430023](#)
- SAC-2P-960/...**
Order No. [1432389](#)
- SAC-2P-961/...**
Order No. [1434620](#)

Pre-assembled connecting cables are also available with M12 screw connection.

UL-Ex, IECEx,
ATEX II 3G Ex nA IIC T4

¹⁾ V4A, 316L electropolished
²⁾ Aluminum, powder-coated
IP66/NEMA 4X

ATEX Ex II 1G Ex ia IIC T4
IECEx
ATEX Ex d IIC T4

V4A, 316L
IP67

UL-Ex, IECEx, ATEX
* Ex nA[nL Gc] IIC T4 Gc, FNICO
** Ex nA[ic Gc] IIB T4 Gc, FISCO
*** Ex nA [ia Ga Da] IIC T4 Gc

Plastic
IP20

–

Plastic/stainless steel
IP67

Remote control solutions

Communication infrastructure

Phoenix Contact offers a comprehensive product range for interference-free data transmission in remote or wide-ranging networks and for worldwide system monitoring. Our high-performance interface devices support all leading bus systems as well as the various transmission media. In addition to copper-based interface devices, we also provide solutions for wireless and fiber optic (FO) transmission.

Industrial communication

- Universal data links – worldwide and control-independent
- Secure communication – integrated security functions protect your applications and expertise.
- Robust hardware – durable, high-performance, and reliable use in harsh industrial environments

Remote control solutions and wireless technology

Copper-based data transmission

We have developed our interface converters and repeaters for your high requirements in process environments. All devices excel thanks to their high insulation voltages between the interfaces, which prevent faults and compensating currents effectively. Network segmentation increases system availability as well as the performance of your application.

Optical data transmission

In recent years, fiber optic data transmission has been playing an increasingly important role, especially in process technology and process engineering. Fiber optic data transmission has become the norm, particularly in critical applications with very high requirements regarding availability. The advantages brought by optical data transmission are indispensable, especially for systems in which explosion protection must be taken into account.

Industrial telecommunications

Global networking of machines and systems. Alarm generation, remote maintenance, and continual data acquisition. From classic analog modems to fast mobile communication routers: we offer the right system for every application.

Wireless

Signals from measuring and monitoring stations are often distributed via various system parts and have to be transmitted over long distances. Modern wireless systems are a flexible, extendable, and low-cost alternative. Depending on the distance to be covered and the signals to be transmitted, various wireless technologies are available such as Trusted Wireless, Bluetooth or GSM mobile communication. Analog and digital I/O signals as well as serial data can therefore be transmitted easily and safely.

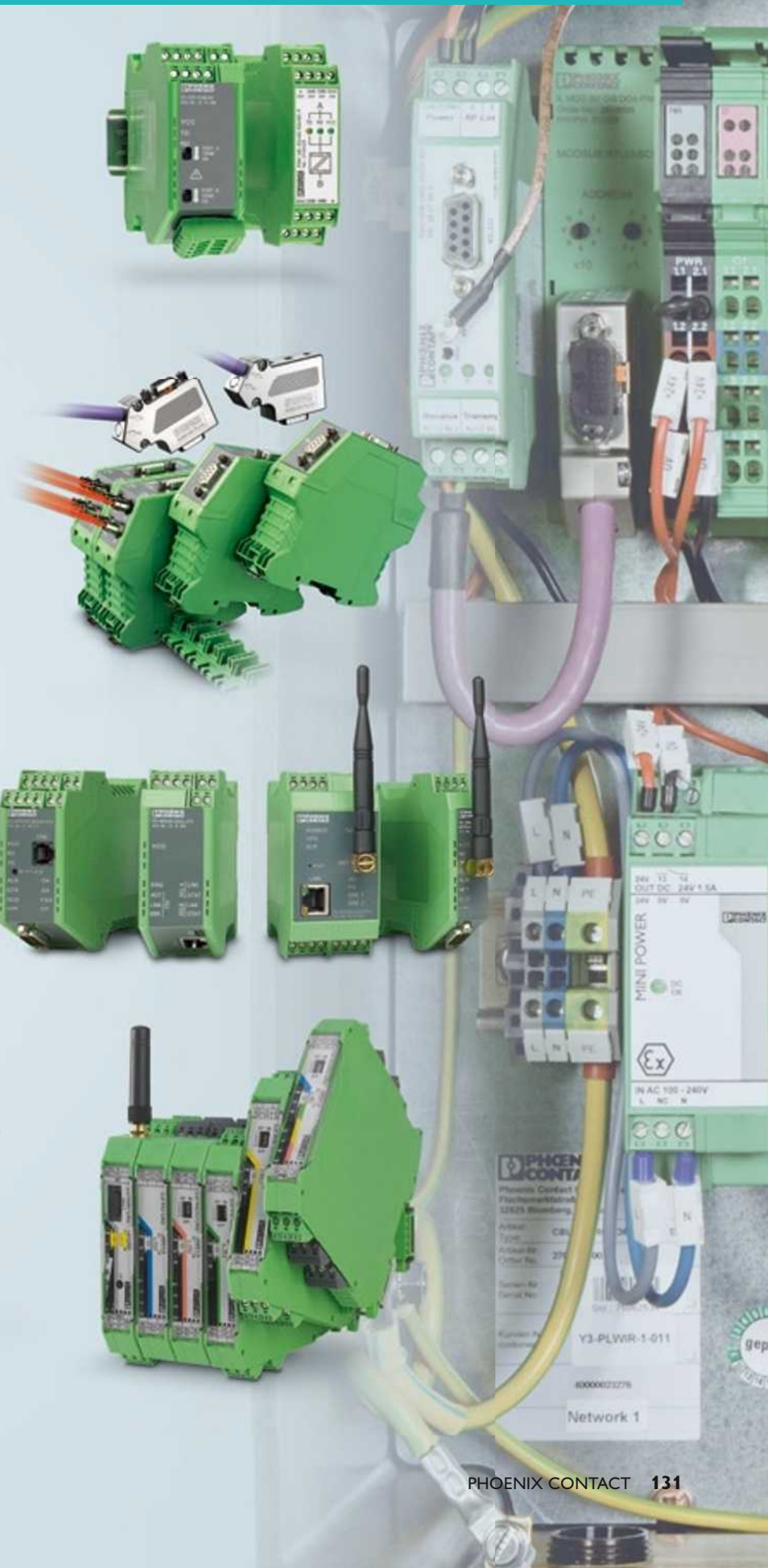

Solutions for the serial connection of distributed I/O devices

Various serial systems, such as Modbus/RTU or PROFIBUS, are used to connect remote I/O (RIO) devices. Various interface devices are required in order to create high-performance and interference-free networks. These devices adapt to different interfaces and provide electrical isolation, as well as increasing the range and speed in the network. Data can be transmitted via copper, fiber optics or wirelessly for a wide range of different requirements.

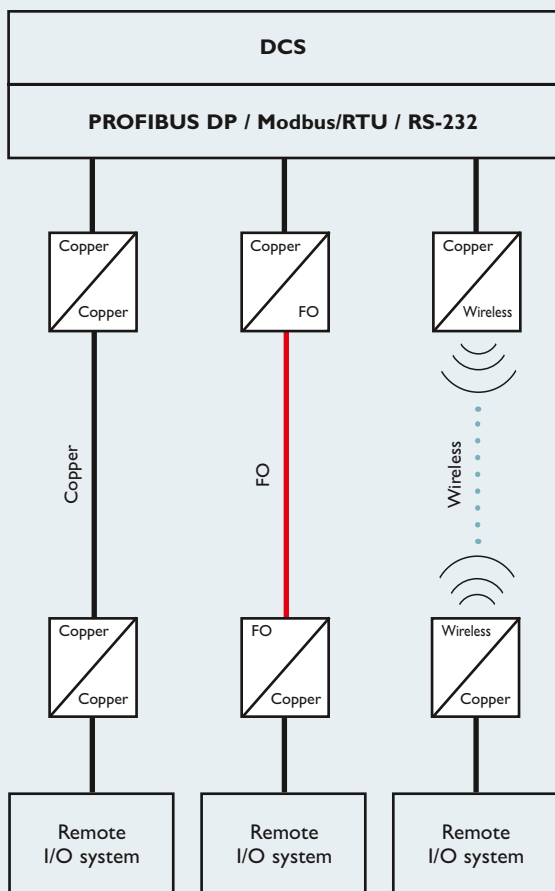

Transmission ranges

- Copper – standard: max. 1200 m (depending on cable type and data rate)
- Copper – SHDSL: up to 20 km
- FO converters
 - 660 nm:
 - 100 m (polymer fiber)
 - 800 m (HCS fiber)
 - 850 nm:
 - 2800 m (HCS fiber)
 - 3300 m (multimode fiberglass 62.5/125)
 - 4500 m (multimode fiberglass 50/125)
 - 1300 nm:
 - 22 km (multimode fiberglass 62.5/125)
 - 25 km (multimode fiberglass 50/125)
 - 45 km (single-mode fiberglass 9/125)
- Can vary depending on the bus system used.
- Wireless
 - Bluetooth: up to 150 m
 - Trusted Wireless 2.4 GHz:
 - up to 800 m with omnidirectional antenna
 - up to 4.5 km with panel antennas
 - Trusted Wireless 900 MHz: 32 km
 - Trusted Wireless 868 MHz: 20 km
- GSM mobile communication: worldwide



Copper Standard	Copper SHDSL	FO media converter	Wireless
-----------------	--------------	--------------------	----------

PROFIBUS DP			
-------------	--	--	--

PSI-REP-PROFIBUS/12MB ^{1) 2)} Order No. 2708863 PSM-ME-RS485/RS485-P ^{1) 2)} Order No. 2744429 PSI-TERMINATOR-PB ¹⁾ Order No. 2313944 SUBCON-PLUS-PROFIB/SC2 Order No. 2708232 SUBCON-PLUS-PROFIB/Pg/SC2 Order No. 2708245	PSI-MODEM-SHDSL/PB Order No. 2313656	PSI-MOS-PROFIB/FO 850 E ^{1) 2) 3)} Order No. 2708274 PSI-MOS-PROFIB/FO 850 T ^{1) 2) 3)} Order No. 2708261 PSI-MOS-PROFIB/FO1300 E ^{1) 3)} Order No. 2708559 PSI-MOS-PROFIB/FO1300 T ^{1) 3)} Order No. 2708892	PSI-WL-RS232-RS485/BT/2DO Order No. 2313805 PSI-WL-RS232-RS485/BT/HL ²⁾ Order No. 2313795 PSI-WL-PROFIB/BT-SET/2DO Order No. 2313876 RAD-2400-IFS ^{1) 2) 3)} Order No. 2901541
---	--	--	---

Modbus/RTU/ASCII			
------------------	--	--	--

PSI-REP-RS485W2 ^{1) 2)} Order No. 2313096 PSM-ME-RS485/RS485-P ^{1) 2)} Order No. 2744429 FL COMSERVER UNI 232/422/485 ^{1) 2)} Order No. 2313452 SUBCON-PLUS M1 Order No. 2761826 SUBCON-PLUS F1 Order No. 2744267	PSI-MODEM-SHDSL/SERIAL Order No. 2313669	PSI-MOS-RS485W2/FO 850 E ^{1) 2) 3)} Order No. 2708339 PSI-MOS-RS485W2/FO 850 T ^{1) 2) 3)} Order No. 2708326 PSI-MOS-RS485W2/FO1300 E ^{1) 2) 3)} Order No. 2708562 PSI-MOS-RS422/FO 660 E ^{1) 2) 3)} Order No. 2708342 PSI-MOS-RS422/FO 660 T ^{1) 2) 3)} Order No. 2708384 PSI-MOS-RS422/FO 850 E ^{1) 2) 3)} Order No. 2708355 PSI-MOS-RS422/FO 850 T ^{1) 2) 3)} Order No. 2708397 PSI-MOS-RS422/FO1300 E ^{1) 3)} Order No. 2708575	PSI-WL-RS232-RS485/BT/2DO Order No. 2313805 PSI-WL-RS232-RS485/BT/HL ²⁾ Order No. 2313795 RAD-2400-IFS ^{1) 2) 3)} Order No. 2901541 RAD-900-IFS 2 ²⁾ Order No. 2901540 RAD-868-IFS ¹⁾ Order No. 2904909
--	--	---	---

RS-232			
--------	--	--	--

PSM-ME-RS232/RS232-P ^{1) 2)} Order No. 2744461 PSM-ME-RS232/RS485-P ^{1) 2)} Order No. 2744416 PSM-EG-RS232/422-P/4K Order No. 2761266 FL COMSERVER BASIC 232/422/485 ^{1) 2)} Order No. 2313478 FL COMSERVER PRO 232/422/485 Order No. 2313465 PSI-DATA/BASIC-MODEM/RS232 ²⁾ Order No. 2313067	PSI-MODEM-SHDSL/SERIAL Order No. 2313669	PSI-MOS-RS232/FO 850 E ^{1) 2) 3)} Order No. 2708371 PSI-MOS-RS232/FO 850 T ^{1) 2) 3)} Order No. 2708423 PSI-MOS-RS232/FO1300 E ^{1) 3)} Order No. 2708588	PSI-GPRS/GSM-MODEM/RS232-QB Order No. 2313106 PSI-WL-RS232-RS485/BT/2DO Order No. 2313805 PSI-WL-RS232-RS485/BT/HL ²⁾ Order No. 2313795 RAD-2400-IFS ^{1) 2) 3)} Order No. 2901541 FL COMSERVER WLAN 232/422/485 Order No. 2313559 RAD-900-IFS 2 ²⁾ Order No. 2901540
--	--	---	--

Approval			
----------	--	--	--

¹⁾ ATEX ²⁾ UL: Class I, Zone 2 and Class I, Div. 2	ATEX Ex II 3 G...	¹⁾ ATEX Ex II 3 G... ²⁾ ATEX Ex II (2) GD [Ex op is]... ³⁾ UL: Class I, Zone 2 and Class I, Div. 2	¹⁾ ATEX Ex II 3 G... ²⁾ UL: Class I, Zone 2 and Class I, Div. 2 ³⁾ IECEx
---	-------------------	---	---

Solutions for creating distributed Ethernet networks

In the past, Ethernet was used exclusively for communication at SCADA level. However, Ethernet is now increasingly being used to transmit video and I/O information for the field level. The physical limitations require alternative solutions for covering large distances. SHDSL technology allows simple two-wire lines, such as existing phone lines, to be used for transmissions up to 20 km. In contrast, fiber optic technology can cover distances of up to 40 km and is also completely immune to electromagnetic interference. At the same time, the fiber optic paths provide high-quality electrical isolation between the connected system parts.

The COMSERVER is available for solutions to retrofit tasks in the vicinity of Modbus systems. The gateway supports easy conversion between Modbus/RTU/ASCII systems and Modbus/TCP controllers.

Modbus/TCP
PROFINET
HSE FOUNDATION Fieldbus

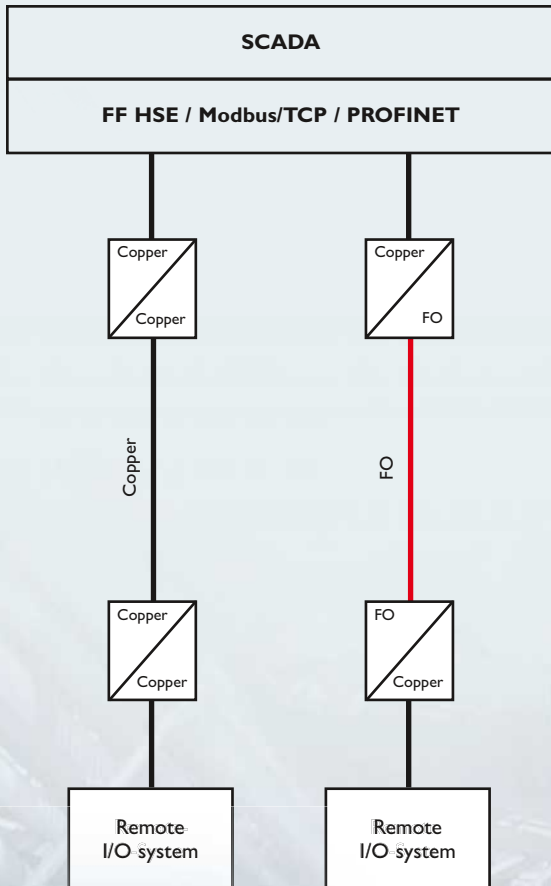

Transmission ranges

- Copper – standard: 100 m
- Copper – SHDSL: up to 20 km
- FO converters:
 - 660 nm:
 - 50 m (polymer fiber 980/1000)
 - 100 m (HCS standard fiber 200/230)
 - 300 m (HCS-GI broadband fiber 200/230)
 - 1300 nm:
 - 2 km (HCS-GI broadband fiber 200/230)
 - 10 km (multimode fiberglass)
 - 36 km (single-mode fiberglass)

Approvals





Serial device server

Ethernet extender

FO media converter

Ethernet patch panel

FL COMSERVER UNI
232/422/485^{a) c) d)}
Order No. 2313452

FL COMSERVER BASIC
232/422/485^{a) c) d)}
Order No. 2313478

FL COMSERVER UNI
232/422/485-T
Order No. 2904817

FL COMSERVER BAS
232/422/485-T
Order No. 2904681

PSI-MODEM-SHD/SL/ETH^{a)}
Order No. 2313643

FL MC EF 1300 MM SC^{a) b) c) d)}
Order No. 2902853

FL MC EF 1300 SM SC^{a) c) d)}
Order No. 2902856

FL MC EF 1300 MM ST^{a) b) c) d)}
Order No. 2902854

FL MC EF WDM-SET SC^{a) c) d)}
Order No. 2902660

FL MC 10/100BASE-T/FO-660^{a)}
Order No. 2708193

FL MC 2000E LC
Order No. 2891056

FL MC 2000E SM40 LC
Order No. 2891156

FL MC 2000T SC
Order No. 2891315

FL MC 2000T ST
Order No. 2891316

FL MC 2000T SM20 SC
Order No. 2891317

FL MC 2000T SM40 SC
Order No. 2891318

FL MC 1000 SC
Order No. 2891320

FL MC 1000 ST
Order No. 2891321

FL-PP-RJ45-SCC^{a)}
Order No. 2901642

FL-PP-RJ45-SC^{a)}
Order No. 2901643

FL-PP-RJ45-LSA
Order No. 2901645

FL-PP-RJ45/RJ45^{a)}
Order No. 2901646

FL-PP-RJ45/RJ45-B
Order No. 2904933

FL-PP-RJ45-SCC/SC041
Order No. 2903532

FL-PP-RJ45-SCC/SC045
Order No. 2904577

FL CAT5 TERMINAL BOX
Order No. 2744610

^{a)} ATEX: Zone 2

^{c)} UL: Class 1 Div 2

^{d)} UL: Class 1 Zone 2

^{a)} ATEX: Zone 2

^{a)} ATEX: Zone 2

^{b)} ATEX: optical intrinsic safety
(up to Zone 1)

^{c)} UL: Class 1 Div 2

^{d)} UL: Class 1 Zone 2

^{a)} ATEX: Zone 2

MM: multimode fiberglass, **SM:** single-mode fiberglass, **ST:** FO connection for ST connectors, **SC:** FO connection for SC duplex connectors, **660:** FO connection for SCRJ connectors (polymer and HCS fibers only), **WDM:** fiber optic path with a single optical fiber (for SC connectors)

Industrial telecommunications – we connect the world

Global networking of machines and systems. Alarm generation, remote maintenance, and continual data acquisition. From classic analog modems to fast mobile communication routers: we offer the right system for every application.

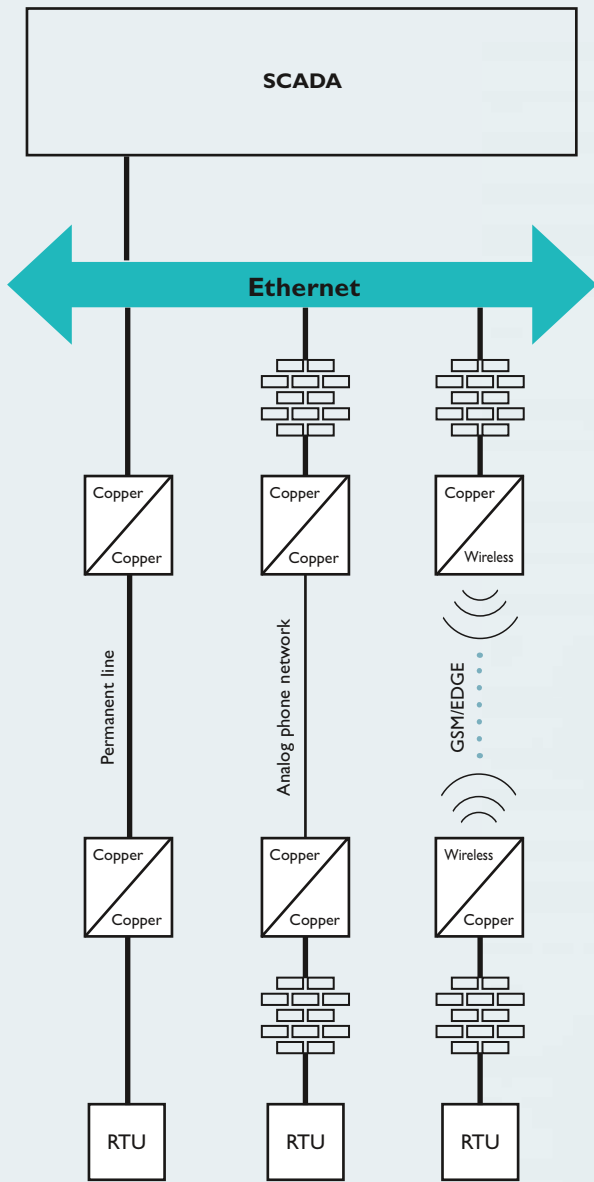



Ethernet extender

Analog LAN modem

Mobile commun. router GPRS/EDGE/UMTS/HSPA

Security router

PSI-MODEM-SHDSL/ETH
Order No. 2313643

PSI-MODEM/ETH
Order No. 2313300

PSI-MODEM-GSM/ETH
Order No. 2313355

PSI-MODEM-3G/ROUTER
Order No. 2314008

FL MGuard RS2000 TX/TX VPN
Order No. 2700642

FL MGuard RS4000 TX/TX VPN
Order No. 2200515

FL MGuard RS2005 TX VPN
Order No. 2701875

FL MGuard RS4004 TX/DTX
Order No. 2701876

Description

- Distances up to 20 km
- Transmission speed of up to 30 Mbps
- Fast startup, Plug and Play
- Point-to-point, redundancy, and line structures
- Integrated log book for line monitoring
- Two digital switching outputs for alarm generation

- Worldwide data links via the public phone network
- Data rates of up to 56 kbps
- Dialing into remote networks using dial-up connection for quick and easy access to machines and systems
- Automatic connection to remote networks for status transmission or in the event of an error

- Worldwide high-speed data links and alarm generation via 3G mobile communication networks
- UMTS/HSPA tri band (850 MHz/900 MHz/2100 MHz) with GPRS/EDGE
- Data rates of up to 7.2 Mbps
- Alarm generation via text message and e-mail
- Firewall and VPN

- 1:1-NAT, NAT, port forwarding, standard routing, stateful inspection firewall, separate input/output rules, data throughput of up to 99 Mbps, -25°C to +65°C, slot for SD card



SHDSL surge protection

Telecommunications surge protection

Surge protection for coaxial cables

Ethernet isolator

DT-TELE-SHDSL
Order No. 2801593

DT-TELE-RJ45
Order No. 2882925

CSMA-LAMBDA/4-2.0-BS-SET
Order No. 2800491

FL ISOLATOR 1000-RJ/RJ
Order No. 2313915

FL ISOLATOR 100-RJ/RJ
Order No. 2313931

FL ISOLATOR 100-RJ/SC
Order No. 2313928

Description

DATATRAB, surge protection for two signal pairs of the SHDSL telecommunications interface.

DATATRAB, surge protection for two signal wire pairs of the DSL telecommunications interface.

Surge protection for UMTS and quad-band GSM antennas, with SMA connector and SMA coupling.

Network isolator for electrical isolation up to 4 kV, 2 x RJ45 socket, for transmission speeds up to 1 Gbps.

Create your own individual remote control system

For a long time, remote control was synonymous with expensive, self-contained systems. In particular, this meant that small external stations were often not monitored. With Phoenix Contact's flexible remote control system, you can now create a customized and inexpensive solution even for small stations. You can decide which functions you require.

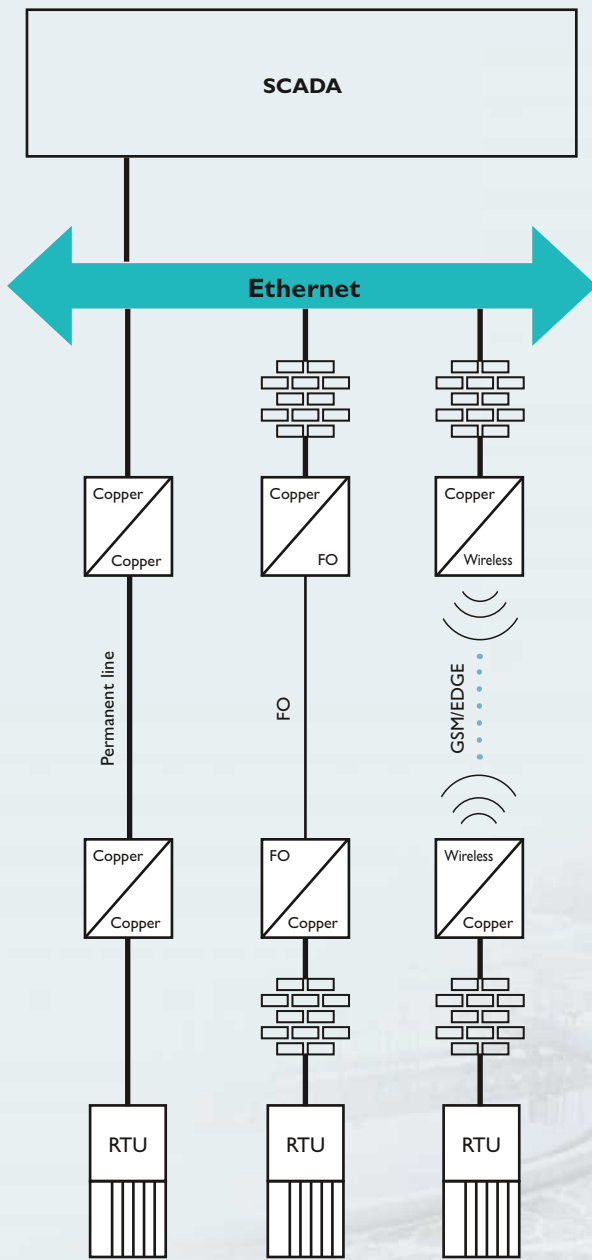

Thanks to special protocols, you can transmit process data reliably over wide area networks, even with low bandwidth and with poor transmission quality. Phoenix Contact offers remote control solutions for virtually all telecommunications networks, such as:

- Analog permanent lines
- Wireless networks such as Bluetooth and Trusted Wireless
- Public phone or mobile communication networks such as DSL, GSM, GPRS, EDGE, and 3G





Remote control software

I/O modules

Remote controllers

RESY-DATA-A LIC
Order No. [2876847](#)
AX ODP SERVER

IB IL 24 DI 4-ME
Order No. [2863928](#)
IB IL 24 DI 16-PAC
Order No. [2861250](#)
IB IL 24 DI 32/HD-PAC
Order No. [2862835](#)
IB IL 24 DO 2-PAC
Order No. [2861470](#)
IB IL 24 DO 4-PAC
Order No. [2861276](#)
IB IL AO 2/SF-PAC
Order No. [2863083](#)

ILC 170 ETH 2TX
Order No. [2916532](#)
ILC 150 GSM/GPRS
Order No. [2916545](#)
ILC 150 ETH
Order No. [2985330](#)

For more I/O terminals, refer to the “conventional signal connection” section.

Description

Use Resy+ to extend our standard controllers to create a remote control station.
Parameterize the remote control communication independently in the programming environment or start up the remote control station with just a few clicks of the mouse using a wizard. Resy+ offers a wide range of interfaces, such as IEC 60870-5-101/104, ODP or Modbus/RTU/TCP.

Digital and analog Inline input and output terminals cover all typical applications in the field of remote control technology.
The I/O devices are connected by a simple or an extended Inline connector, depending on the number of channels. Multi-conductor connection technology is used in both cases. The Inline terminals can be marked using hinged marking fields.

The remote controller from Phoenix Contact acquires data and stores it temporarily, sends alarms, and controls the connected process. The controller can be extended into various performance classes and supports highly modular expansion by means of digital and analog inputs and outputs, thus providing the optimum hardware solution for your remote control technology tasks.

Solutions for the transmission of I/O and serial signals

Radioline is the new wireless system for large systems and networks with up to 250 devices. Whether I/O signals or serial data, only one wireless system is required for various different applications. Inputs and outputs are easily assigned by simply turning the thumbwheel – without any programming.

A multipoint multiplexer can be implemented with the new front module for RS-485 2-wire bus systems, you can use it to distribute I/O signals between multiple stations without the need for any software configuration.

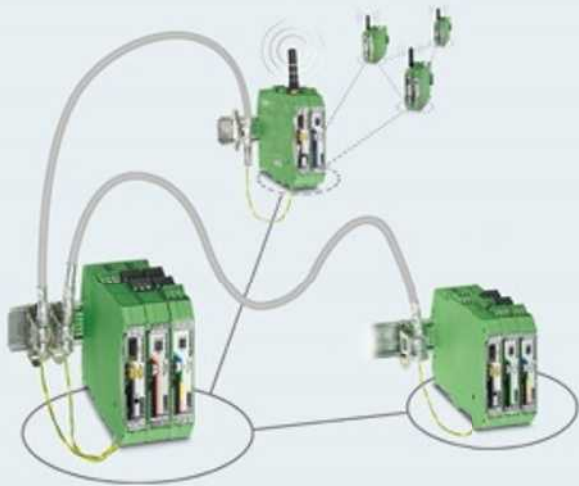

With the new Radioline RS-485 modules, an existing wireless network can be extended to up 98 stations starting at the wireless master. This means that I/O data can now be distributed very easily between all stations, whether a wireless station or an RS-485 station, by simply turning the thumbwheel.

Trusted Wireless 2.0

Trusted Wireless technology is specifically designed for the reliable transmission of data and signals over long distances. The new Version 2.0 offers adjustable data rates, encryption, extended diagnostics, and parallel operation of multiple networks.

Distances in the kilometer range can be achieved with the 2.4 GHz system or even greater distances can be covered with the 868 MHz system.

Longer transmission paths can be covered using repeater stations.



**TRUSTED
WIRELESS**



Front modules	I/O modules	Accessories
RAD-2400-IFS ^{1) 2) 3)} Order No. 2901541	RAD-DI4-IFS Order No. 2901535	RAD-CONF-RF3 RF band 3 Order No. 2902814
RAD-900-IFS ²⁾ Order No. 2901540	RAD-DOR4-IFS Order No. 2901536	RAD-CONF-RF5 RF band 5 Order No. 2902815
RAD-868-IFS ¹⁾ Order No. 2904909	RAD-AI4-IFS Order No. 2901537	RAD-CONF-RF7 RF band 7 Order No. 2902816
RAD-RS485-IFS Order No. 2702184	RAD-AO4-IFS Order No. 2901538	RAD-MEMORY (freely configurable) Order No. 2902828
	RAD-DAIO6-IFS Order No. 2901533	SKS 8-SNS35 Order No. 3062786
	RAD-DI8-IFS Order No. 2901539	
	RAD-DO8-IFS Order No. 2902811	
	RAD-PT100-4-IFS Order No. 2904035	

General data		
Supply voltage	19.2 V DC ... 30.5 V DC 10.8 V DC ... 30.5 V DC	19.2 V DC ... 30.5 V DC
Degree of protection	IP20	IP20
Ambient temperature	-40°C ... +70°C	-40°C ... +70°C
Permissible humidity (operation)	20% ... 85%	20% ... 85%
Housing material	Polyamide PA, non-reinforced	Polyamide PA, non-reinforced
Dimensions W / H / D	17.5 / 99 / 114.5 mm	17.5 / 99 / 114.5 mm
Screw connection solid / stranded / AWG	0.2 ... 2.5 mm ² / 0.2 ... 2.5 mm ² / 24 ... 14	0.2 ... 2.5 mm ² / 0.2 ... 2.5 mm ² / 24 ... 14
Wireless path		
Direction	Bidirectional	–
Frequency range	2.4002 GHz ... 2.4785 GHz 902 MHz ... 928 MHz 869.4 MHz ... 869.65 MHz	–
Transmission power	100 mW (adjustable) 1 W (adjustable) 500 mW (adjustable)	–
Security	128-bit data encryption	–
Serial interface	RS-232/RS-485	–
Conformance/approvals		
Conformance	CE-compliant/ R&TTE Directives 1999/5/EC	CE-compliant

¹⁾ATEX Ex II 3 G...

²⁾UL: Class I, Zone 2 and Class I, Div. 2

³⁾IECEX

ATEX Ex II 3 G...

UL: Class I, Zone 2 and Class I, Div. 2

IECEX

Services and support

In addition to future-oriented products, Phoenix Contact offers a comprehensive range of services

Wherever you are in the world, our global network means that you can rely on our service. Being at home all over the world and speaking the language of the user is what we understand by customer proximity. We live up to this with more than 50 Phoenix Contact subsidiaries and in excess of 30 representatives in other countries.



Terminal strip production

Pre-assembled terminal strips enable you to both streamline your process sequences and reduce installation time. We supply your terminal strips fully marked.



Control box production

We can produce fully equipped control boxes to your specifications. Our service even includes putting together custom product sets.



Marking service

With CLIP PROJECT, the planning and marking software, you can create markings to suit your wishes. Just use the built-in e-mail function to send the data to us, and we will deliver ready-printed marking materials directly to your production facility. Quick and easy – all you need to do is mount the materials.

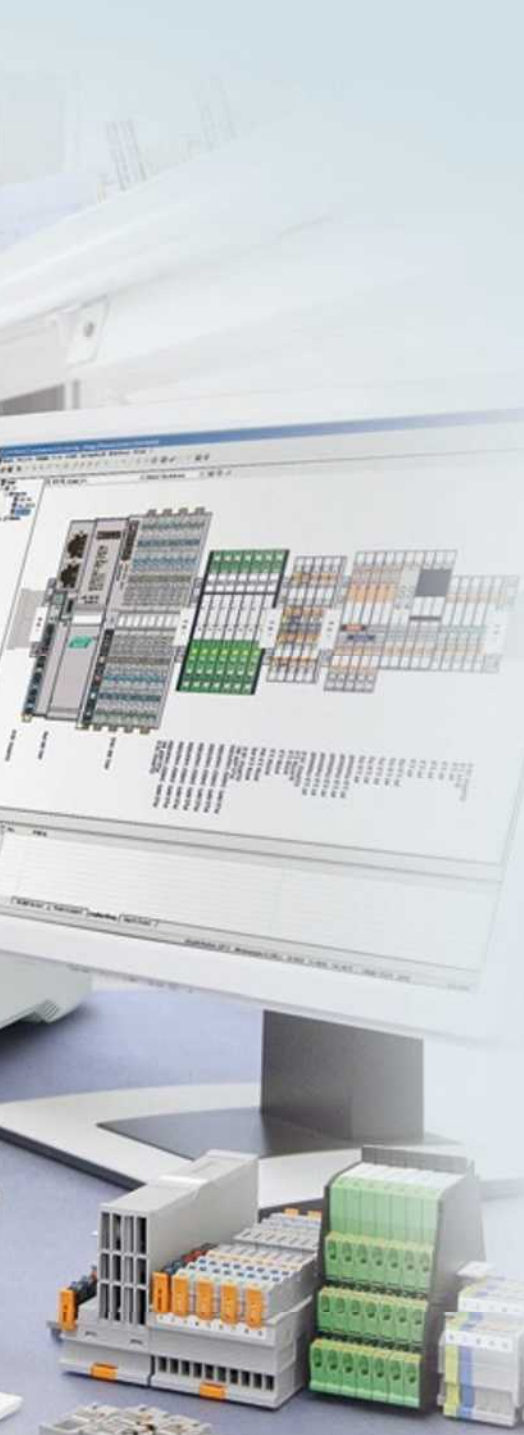
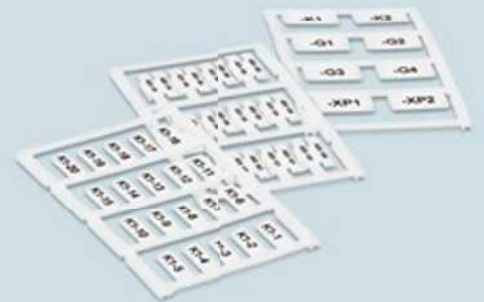

CLIPSAFE

Everything from a single source

Reduce your assembly and approval costs. With your input, we can design and develop the right solution for your application using the wide range of CLIPSAFE empty housings.

Just call us or send us an e-mail, and we will deliver exactly what you need.



Empty Ex housings

Choose the right stainless steel housing for your application from 140 Ex-approved versions. Custom dimensions and surface treatments are available on request. The housings are supplied with corresponding component approval in accordance with ATEX and IECEx.



Empty Ex housings processed according to customer specifications

We can customize the housings according to your specifications with threads, bore holes, and rectangular cutouts, taking Ex standards according to ATEX and IECEx into consideration. The housings are supplied with corresponding component approval.

Customer-specific solutions

Please use the inquiry form on the website to request a custom terminal box and housing solution. You can easily describe your requirements using the form. We will then prepare an individual quote based on the information provided.

Just enter the web code into the search field on our website.

 Web code: #0140



Ex terminal boxes equipped according to customer specifications

If desired, the CLIPSAFE empty housings can be supplied ready equipped with terminal blocks and cable glands. The terminal boxes are supplied with corresponding device approval in accordance with ATEX and IECEx for use in potentially explosive areas.



Ex control boxes according to customer specifications

Custom control boxes with electronic components are available on request.

CLIPSAFE

Innovative housing concept

Phoenix Contact has many years of experience developing reliable products for the ex area.

Close contact with our customers, knowledge of your requirements, our design capabilities and expertise in production are important features of the new CLIPSAFE stainless steel housing series.

A housing concept – made for real-life applications.

Surface brushed, 240 grain, electropolished on request

The marking label is fitted outside the seal area

Design data and equipment tables

CAD drawings in STEP, IGES, and DXF format can be downloaded directly from the website in the product area for the respective empty housing.

You can find equipment information regarding the maximum permissible number of Ex terminal block screw connections and cable glands that can be installed in the download area for the empty housings.



Comprehensive product range

The housings are available as door or cover versions in nine different depths and sizes up to 1000 mm x 1000 mm x 300 mm. The robust housings made from up to 2 mm thick high-grade 1.4404 (V4A), AISI 316L stainless steel are ideal for use under extreme conditions.



Flexible door stop

The door stop can be easily changed according to your individual requirements or the installation situation. The 135° opening angle of the door guarantees comfortable work during maintenance and servicing. The special door and cover seal guarantees a reliable seal even after it has been opened multiple times.

Defined stops and the special seal support ensure optimum seal compression

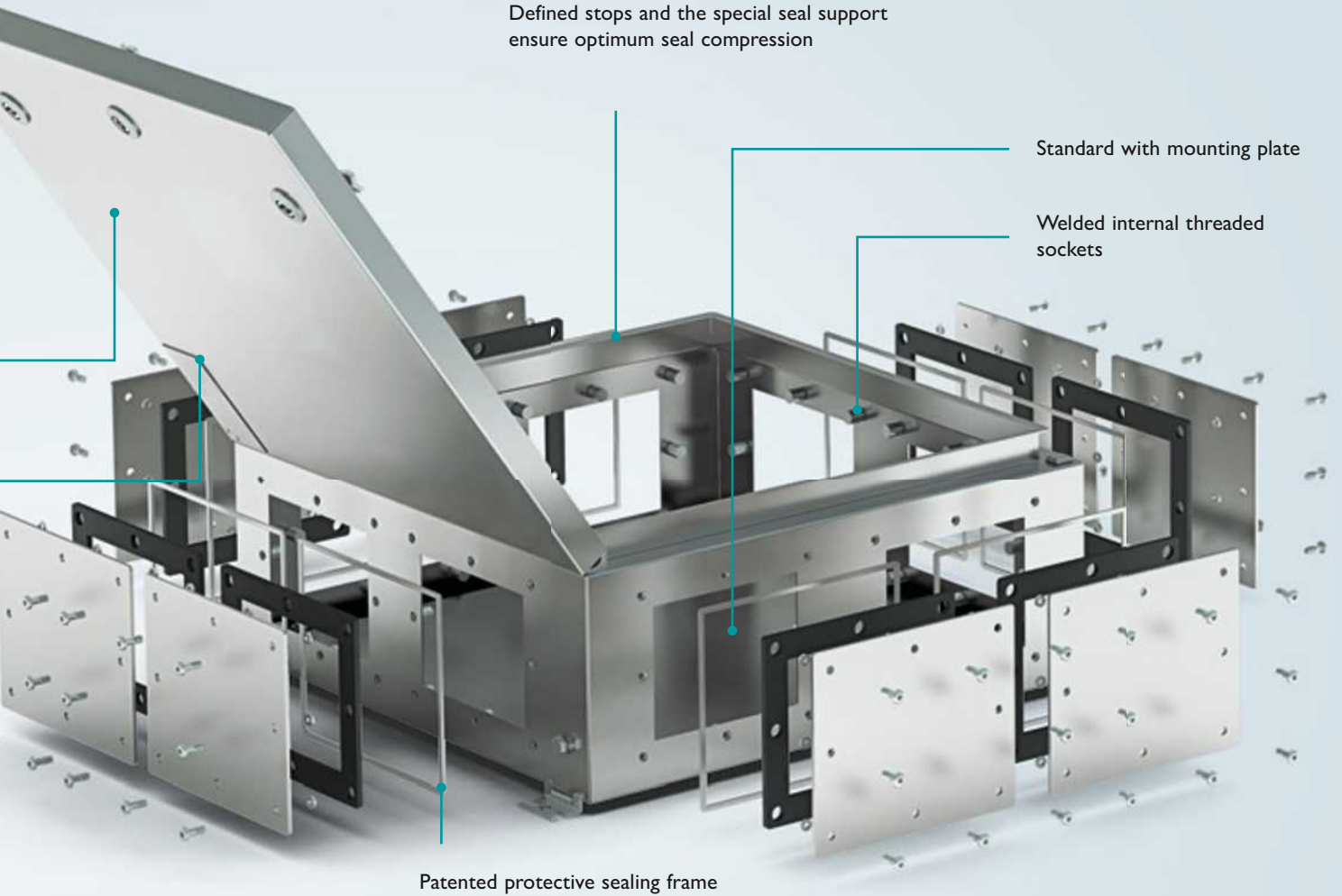

Flexible wall fastening

The mounting brackets that are supplied as standard can be flexibly adapted to the installation situation. Welded-on mounting brackets are available on request.



Individual flange plate fixing

The terminal boxes and empty housings can be equipped with flange plates for a depth of 160 mm or more on up to four sides. The flange plates are equipped with a patented protective sealing frame and with captive mounting screws.



Protection against moisture and dirt

A drainage channel integrated in the housing design prevents the ingress of moisture and dirt when opened. The flat seal edge protects against injury during installation and when carrying out maintenance and servicing.

CLIPSAFE

Stainless steel empty housings for the ex area

The new CLIPSAFE stainless steel housings provide comprehensive protection for your applications in industrial environments and in process engineering.

The housing range consists of 140 standardized housings in sizes up to 1000 x 1000 x 300 mm. We can machine these to your specifications if desired. The housings have ATEX and IEC Ex approval and are designed for a temperature range from -55°C to +135°C. The door opening can be opened up to 135° and the stop can be changed. Various different door and cover versions are also available.



Stainless steel terminal boxes for the ex area

If desired, the CLIPSAFE stainless steel empty housings can be supplied ready equipped with components and cable glands. Flange plates are available on up to four sides of the housing, including patented seal protection.

We also offer housing adjustments using threads, bore holes, and rectangular cutouts with consideration given to normative specifications. The housings are supplied with corresponding device approval for use in potentially explosive areas.



- Innovative product range of high-quality stainless steel housings as the basis for individual terminal boxes
- Reduced assembly and approval effort, thanks to ready-equipped terminal boxes
- Individually equipped with all approved terminal blocks from the CLIPLINE complete system
- Can be equipped with approved controller and interface components on request
- Professional customer support and short delivery times, thanks to worldwide sales network

Main features

- Approvals: ATEX and IEC Ex
- Stainless steel AISI 316L/1.4404
- Material thickness: 1.5 mm ... 2 mm
- Temperature range: -55°C ... +135°C
- Door opening: up to 135°
- IP66 in accordance with EN 60529
- NEMA 4X in accordance with NEMA 250

Cable glands for the ex area

Plastic or metal cable glands are available. Plastic screw connections are available in Ex e/Ex i versions and satisfy the requirements of both the ATEX and IECEx directives. Metal screw connections are available in a standard and EMC version.



- Large sealing area and high strain relief force, thanks to laminated clamping cage principle
- Permanent braided shield contact by means of grounding cones in the EMC screw connections
- Vibration-proof plastic screw connections with protection against over-tightening of the cap nut
- International approvals

Main features

- Degree of protection: IP66/IP68, up to 5 bar (30 minutes)
- Glow-wire test: 750°C for plastic
- Halogen-free
- Approvals: ATEX and IECEx

Planning and marking software

The CLIP PROJECT range enables quick planning and marking from the field to the control cabinet. With a click of the mouse, the software creates labels for terminal blocks, conductors, and equipment.

In addition, CLIP PROJECT creates all the data for the three-dimensional mechanical layout of your application.

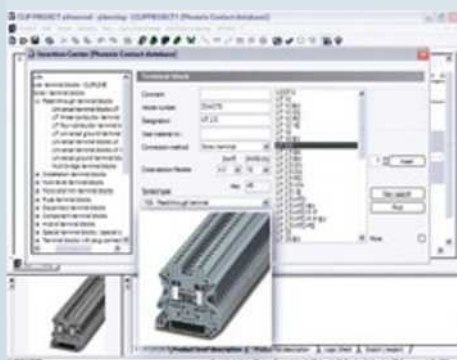
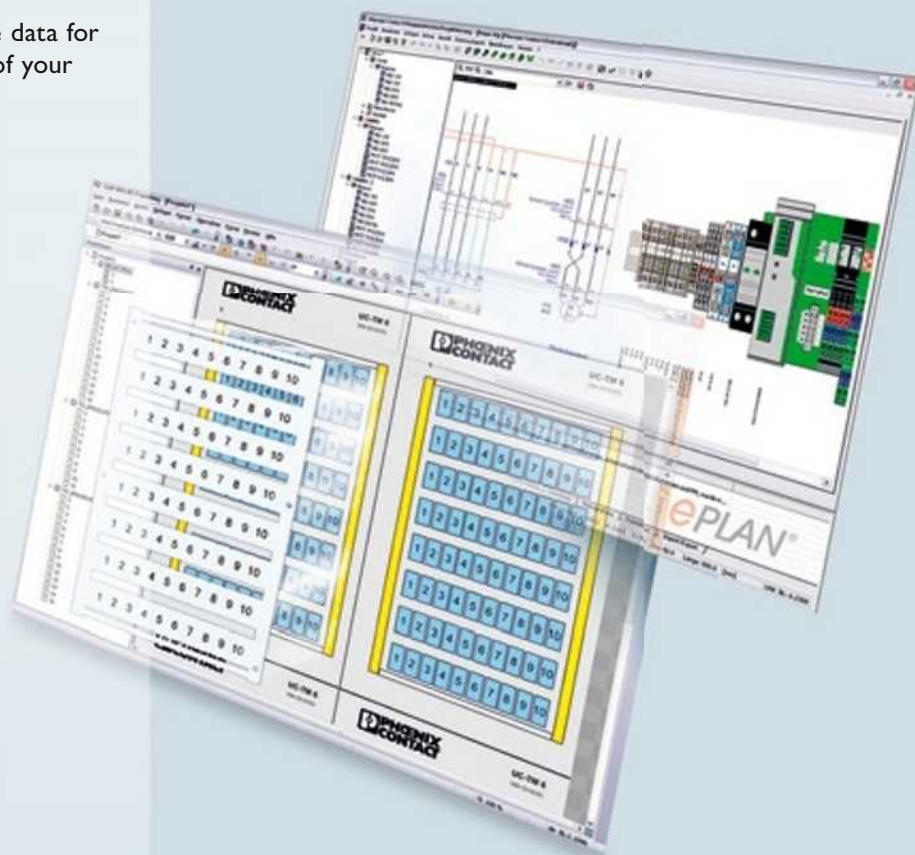

The configured terminal strips can be distributed across several DIN rails in order to determine the exact space requirements for installation.

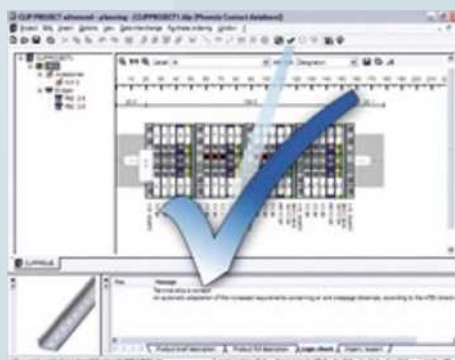

The automatic correction function checks the configured terminal strip and automatically adds any missing accessories. 2D and 3D design data is available with a click of the mouse.

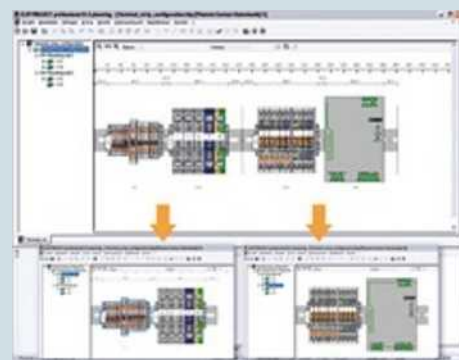

During selection, all Phoenix Contact products that are suitable for DIN rail mounting are displayed as a preview so that products can be selected quickly.

Services: terminal strips, control boxes, planning and marking software



Complete documentation and an effective 3D preview are available for the quick and error-free mechanical layout of the terminal strips.

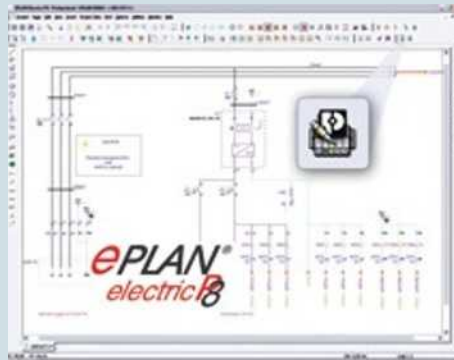

By integrating CLIP PROJECT in EPLAN P8, terminal strips are automatically produced from the circuit diagram in CLIP PROJECT. The product data is written back to the EPLAN parts lists via the bidirectional interface.



Phoenix Contact provides a terminal strip service. The terminal strips configured to your specifications can be ordered using the e-mail function. Phoenix Contact will supply the terminal strips promptly.

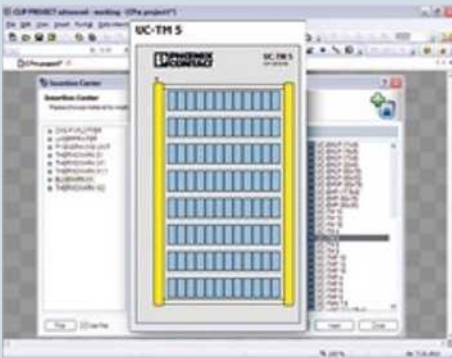

During selection, the marking materials are displayed as a preview so that products can be selected quickly.

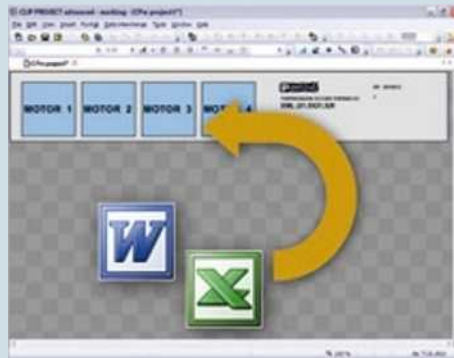

Interfaces to all CAE systems and spreadsheet and word processing programs are provided for the open exchange of data.

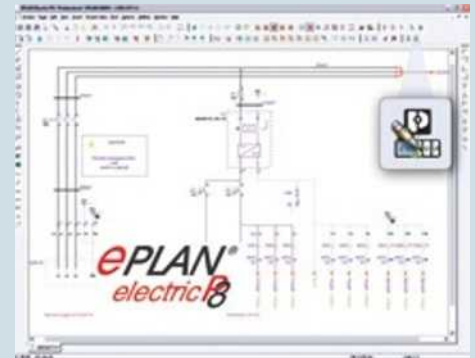

By integrating CLIP PROJECT into EPLAN P8, the marking data for terminal, conductor, and device marking can be automatically taken from the circuit diagram.



The online update immediately provides the user with new products and program extensions for the marking and planning module.

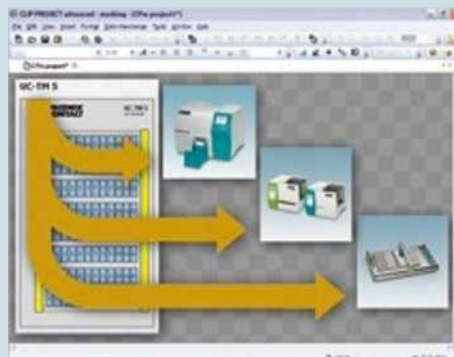

All Phoenix Contact output devices and standard office printers can be controlled easily with just one piece of software.

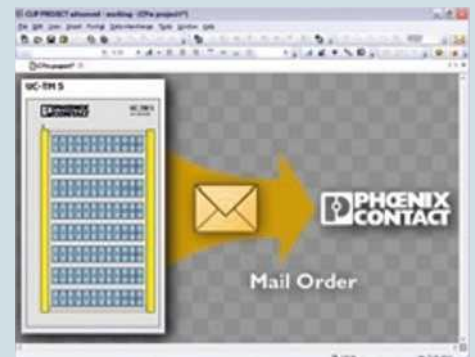

Phoenix Contact provides a marking service. Orders can be placed by e-mail and all items are printed and supplied to customer specifications.

CLIP PROJECT advanced planning and marking software

The CLIP PROJECT advanced program enables the quick planning and configuration of terminal strips for the control cabinet and field as well as custom-marking of terminal blocks, cables and lines, and devices and systems.

- Planning of terminal strips with components from the CLIPLINE, INTERFACE, TRABTECH, and AUTOMATION product ranges
- The automatic correction function performs a logical test of the terminal strips and automatically adds the necessary accessories, such as covers and end brackets
- The terminal strip configurator enables the distributed arrangement of individual terminal strips on different DIN rails
- 3D preview and complete documentation of the assembled DIN rails, such as order and mounting lists
- High-performance import function for marking information and comprehensive design options for custom-marking terminal blocks, cables and lines, and devices and systems
- Numerous sort and filter functions for efficient organization of your print jobs
- Support for all marking materials and output devices from Phoenix Contact
- Automatic Internet update
- Intuitive Windows® user interface
- To reduce engineering costs and improve data quality, CLIP PROJECT advanced supports data exchange with electrical planning systems in both directions:
- With the circuit diagram as the basis, the required products are automatically selected and all their data is written back to the parts lists
- The marking information can be automatically exported and assigned to the desired marking materials
- In order for the marking to be assigned clearly, even in the case of extensive projects, the project structure tree from the CAE system has been adopted in CLIP PROJECT – this also allows the marking to be output to subprojects

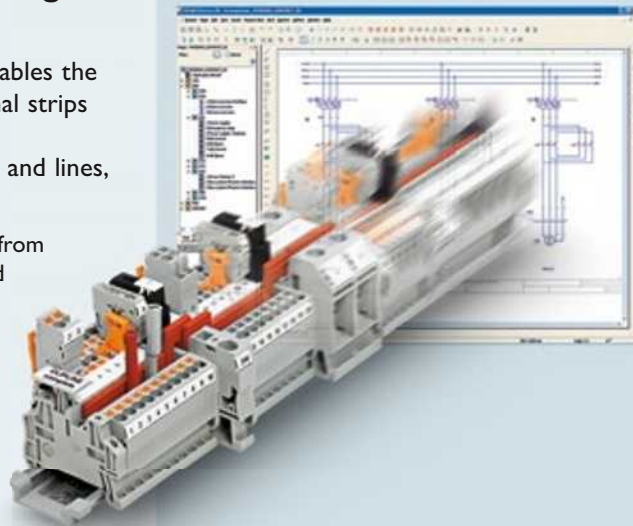

General data

Software interface	EPLAN 5.7 EPLAN Electric P8 AUCOTEC ELCAD AUCOTEC Engineering Base AUCOTEC RUPLAN ZUKEN E³ Bentley Promis-e WSCAD IGE XAO PC-Schematic AUTOMATION SDProget SPAC
--------------------	---

System requirements

Operating systems	MS Windows XP SP3 MS Windows Vista MS Windows 7 (32/64-bit) MS Windows 8 (32/64-bit)
-------------------	---

Technical data

Ordering data

Description	Type	Order No.	Pcs./Pkt.
CLIP PROJECT advanced, planning and marking software, German/English/French/Dutch/Italian/Spanish/Russian/Polish/Hungarian/Czech/Turkish/Portuguese/Chinese and Japanese	CLIP-PROJECT ADVANCED	5146040	1

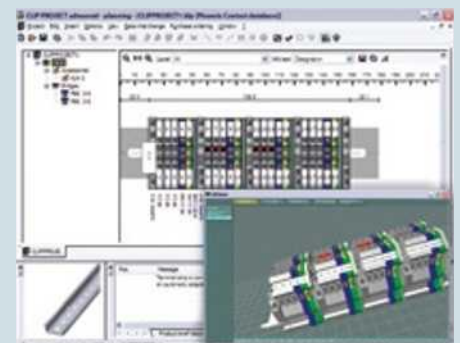

CLIP PROJECT professional planning and marking software

The CLIP PROJECT planning and marking software is available in both an advanced and professional version.

- The professional version also includes an efficient template designer, which can be used to design custom labels and adapt existing material descriptions
- Graphics, various barcode types, and geometric elements such as squares, circles, and lines can be accessed for design work
- Data can also be imported into the templates from various data sources
- Quick, easy, and flexible adaptation to changing requirements

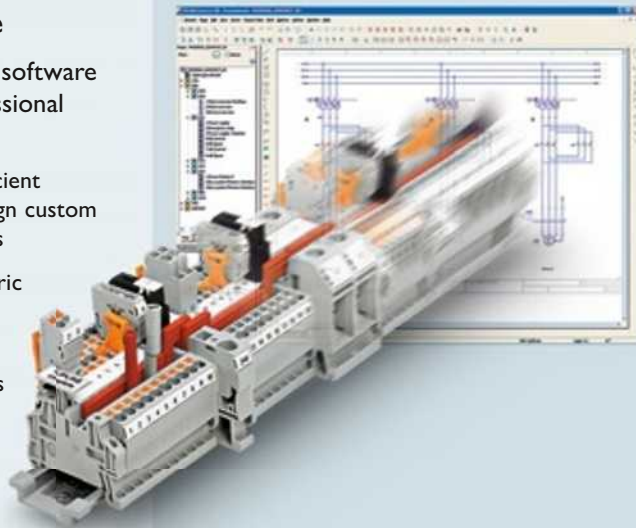

Technical data

General data

Software interface	EPLAN 5.7 EPLAN Electric P8 AUCOTEC ELCAD AUCOTEC Engineering Base AUCOTEC RUPLAN ZUKEN E ³ Bentley Promis-e WSCAD IGE XAO PC-Schematic AUTOMATION SDProget SPAC
--------------------	---

System requirements

Operating systems	MS Windows XP SP3 MS Windows Vista MS Windows 7 (32/64-bit) MS Windows 8 (32/64-bit)
-------------------	---

Ordering data

Description	Type	Order No.	Pcs./Pkt.
CLIP PROJECT professional, planning and marking software, with template designer, German/English/French/Dutch/Italian/Spanish/Russian/Polish/Hungarian/Czech/Turkish/Portuguese/Chinese and Japanese	CLIP-PROJECT PROFESSIONAL	5146053	1

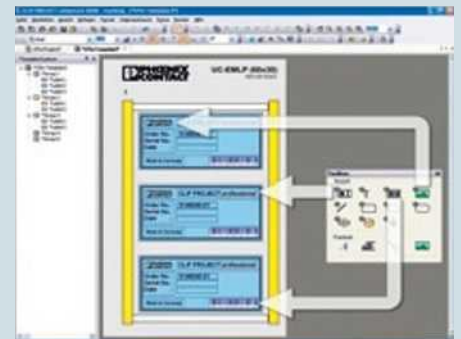

Services for functional safety

In addition to components for functional safety, we support you with individual services for safe operation in process engineering systems. Whatever the product, our industry experts help you plan and implement the safety lifecycle in accordance with EN 61511 as well as PLT safety equipment. Furthermore, the integration of machines in process systems may require the Machinery Directive to be applied. With our services in accordance with EN 13849, we are on hand to assist you with this.

Your advantages:

- Comprehensive support from industry professionals
- Flexible help during all project phases
- Time savings, thanks to outsourcing
- Building competence through employee qualification





Consultation

We provide advice regarding the planning and implementation of your system.

- Design of the safety lifecycle
- Design of PLT safety equipment
- Interfaces: Pressure Equipment, Machinery, ATEX, EMC, Low Voltage Directive
- Design of proof tests

Engineering

To certify the safety integrity, we determine the SIL of the safety functions with the help of your technical documentation. These must be sufficiently robust to withstand random errors.

In the case of requirements according to the Machinery Directive, we implement the entire safety lifecycle process.

Seminars

Basics of functional safety in process technology

- Requirements
- Risk identification and analysis
- SIL determination

Application of EN 61511

- Safety lifecycle
- Functional safety management
- Safety function design
- Software development
- Verification and validation

Integration of machines in process engineering systems

There are often interfaces between the requirements for the process industry and for machine safety: for example, packing machines or machines for transporting containers are also used in process engineering systems.

In such cases, an operator becomes the manufacturer and is responsible for the conformity assessment.

We support you in complying with the specific requirements of machine safety and safeguarding interfaces for the safety areas.

Scope of the Machinery Directive

Linking these machines can create assemblies of machinery. Modifications to machines and systems are subject to the definition of the essential change.



SRS

PFD_{avg}

RRF

IEC 61511

FMEDA

BPCS

SIS

IEC 61508

PHA

HAZOP

SIL

SIF

LOPA

Basic principles

Principles of explosion protection

The chemical and petrochemical industries involve industrial processes which produce explosive atmospheres. They are caused, for example, by gases, fumes or vapors. Explosive atmospheres are also likely to occur in mills, silos and sugar and fodder factories due to the dust present there. Therefore, electrical devices in potentially explosive areas are subject to special directives.

Ensuring the safety of people, achieving a safe and error-free production process, and having a clean working environment are important aims. The way to achieve these aims is to be aware of how explosions occur wherever combustible materials, oxygen, and sources of ignition can come together, and how to avoid them.

For more information about explosion protection, please refer to our brochure entitled "Explosion protection – Theory and practice".



Directives, standards, and regulations

European Parliament directive 94/9/EC (formerly ATEX 100a) of March 23, 1994 (ATEX manufacturer directive) is of particular importance within CENELEC (European Community and Western European EFTA states). It is designed to facilitate the harmonization of legal provisions in the member states of the European Union for devices and protective systems in terms of ensuring correct use in potentially explosive areas.

The directive is applied to devices and protective systems in terms of ensuring correct use in potentially explosive areas. The scope of this directive also includes safety, monitoring, and control devices which are used outside of potentially explosive areas, but which are necessary for, or contribute towards, the safe operation of devices and protective systems with respect to explosion hazards.

Among other things, this directive governs the classification and marking of devices for potentially explosive areas. A distinction is made between two equipment groups:

Equipment group I

Devices for firedamp areas (mines) which are susceptible to pit gases (methane) and/or combustible dusts (coal dust).

Equipment group II

Devices for areas with a danger of gas explosions, excluding mines susceptible to firedamp. This also includes equipment for the chemical, petrochemical, and pharmaceutical industries, as well as for wastewater treatment.

Marking	Typical gas	Ignition energy/ intrinsic safety
IIA	Propane	> 180
IIB	Ethylene	60 ... 180
IIC	Hydrogen	< 60

Gas group

Marking	Dust
IIIA	Combustible flyings
IIIB	Non-conductive dust
IIIC	Conductive dust

Dust group

Classification into temperature classes (for gases)

Simply dividing the various gases into explosion or gas groups according to their minimum ignition energy is not sufficient to describe the gases adequately with regard to their explosive properties. A gas may explode either when the ignition energy is exceeded or where there is an excessively high temperature caused by a hot surface. This ignition temperature is, however, not usually linked to the ignition energy, i.e., a gas with a low ignition energy does not necessarily explode at a low temperature. Consequently, electrical equipment that is used directly in potentially explosive areas is divided into temperature classes. Temperature classes define the maximum surface temperature even in the event of errors. Parallel to this, the gases are classified according to their different ignition temperatures.

Temperature class	Maximum permissible surface temperature of the equipment	Ignition temperatures of combustible materials
T1	450°C	> 450°C
T2	300°C	> 300°C ≤ 450°C
T3	200°C	> 200°C ≤ 300°C
T4	135°C	> 135°C ≤ 200°C
T5	100°C	> 100°C ≤ 135°C
T6	85°C	> 85°C ≤ 100°C

Substance	T _{ign}	E _{min}	Group
Ethoxyethane	170	190	IIB
Ethylene	425	82	IIB
Ammonia	630	14000	IIA
Butane	365	250	IIA
Methane	595	280	I
Propane	470	250	IIA
Carbon disulfide	95	9	IIC
Hydrogen	560	16	IIC



Temperature information (for dusts)

Simply dividing the various dusts based on their flammability and conductivity properties is also not sufficient to describe the dusts adequately with regard to their explosive properties.

Dusts may explode where there is an excessively high temperature caused by a hot surface. Equipment which is used directly in areas with a danger of dust explosions is therefore marked with a temperature value.

The temperature value defines the maximum surface temperature of the device even in the event of errors and it is vital that this temperature value is not the same as the surface temperature of the housing.

The user must be aware of dusts present in areas with a danger of dust explosions, as well as their minimum ignition temperatures. If they are not known, they can be determined in suitable laboratories using the methods specified in IEC 61241-2-1.

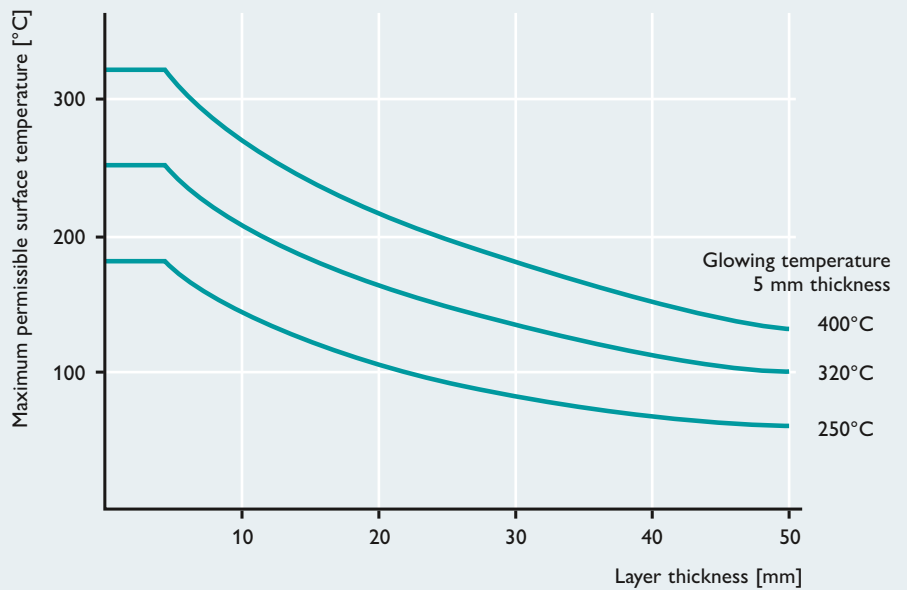

The maximum surface temperature of the equipment must be compared with the minimum ignition temperature of the dust cloud, taking a safety factor into consideration. The maximum surface temperature of the equipment may only amount to two thirds of the minimum ignition temperature of the dust cloud.

If a layer of dust accumulates on the equipment, the minimum ignition temperature of the dust layer must also be considered. Please refer to the diagram for the correlation between the maximum permissible surface temperature and the thickness of the dust layers (EN 61241-14).



Zone classification

Zone 0

Area in which a hazardous explosive gas atmosphere is present for continuous, frequent or long periods. These conditions are usually present inside containers, pipelines, apparatus, and tanks.

Zone 1

Area in which a hazardous explosive gas atmosphere is to be expected only occasionally during normal operation. This includes the immediate area surrounding Zone 0, as well as areas close to filling and emptying equipment.

Zone 2

Area in which a hazardous explosive gas atmosphere is not expected during normal operation; however, if it does occur, it is only for a short time. Zone 2 includes areas that are used exclusively for storage, areas around pipe connections that can be disconnected, and generally the intermediate area surrounding Zone 1.

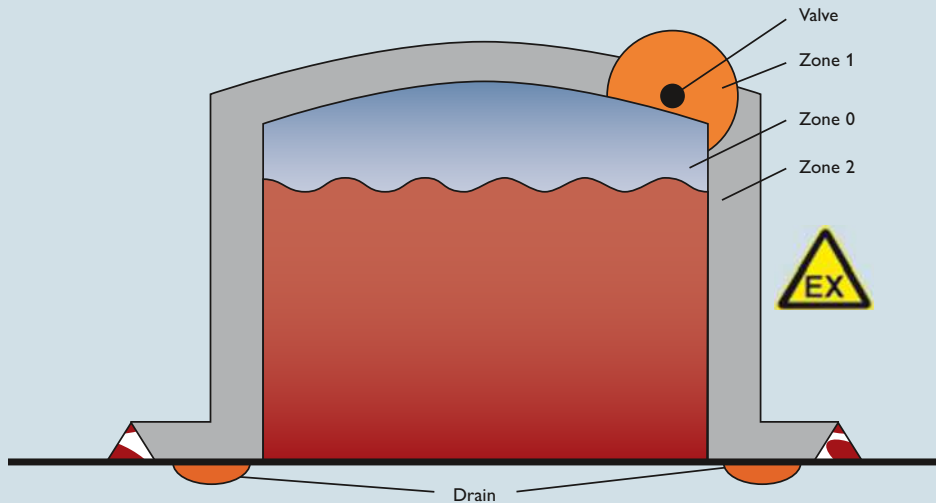

Example of zone classification

Zone classification of a liquid tank (areas with a danger of gas explosions)

Areas that are potentially explosive as a result of combustible dusts are divided into the following zones in accordance with EN 60079-14 (formerly: EN 61241-14):

Zone 20:

Area in which an explosive atmosphere consisting of dust/air mixtures is present for continuous, frequent or long periods.

Zone 21:

Area in which an explosive atmosphere consisting of dust/air mixtures is to be expected only occasionally.

Zone 22:

Area in which an explosive atmosphere caused by swirled up dust is not expected; however, if it does occur, it is only rarely and only for a short time.

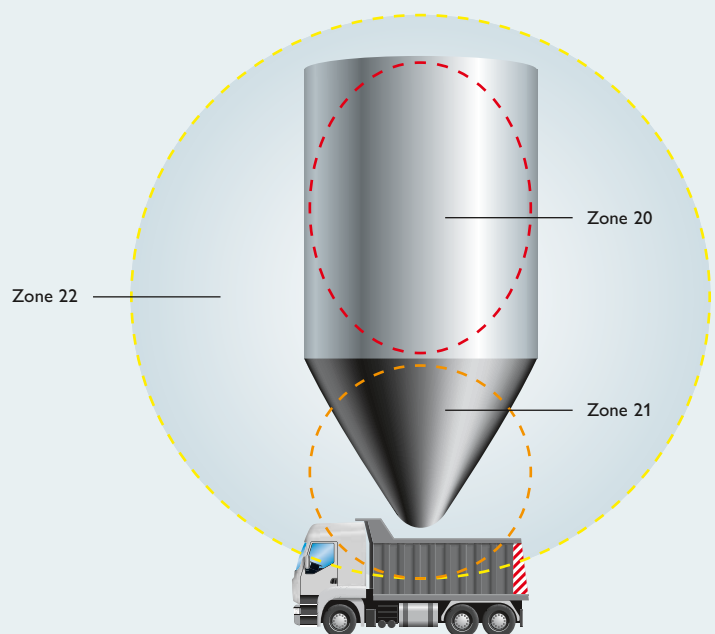

Zone classification using the example of a silo (areas with a danger of dust explosions)

Categories

The ATEX Directive assigns devices for use in potentially explosive areas to categories. In EN 60079-0, "Equipment Protection Level (EPL)" is the term used instead of "category". In the same way that there are different zones, there are also different equipment categories. These consist of categories M1 and M2 for group I and categories 1, 2, and 3 for group II.

The categories for equipment group II are described in more detail below:

Category 1

Devices constructed to guarantee a very high degree of safety. Devices in this category must guarantee the required degree of safety even in the unlikely event of a device failure, and therefore be provided with measures to protect against explosion, so that if one installation protection measure fails, a second independent installation protection measure guarantees the required degree of safety, or if two independent errors occur, the required degree of safety is guaranteed.

Marking	Zone	Also possible
1	0	1 and 2
	20	21 and 22
2	1	2
	21	22
3	2	
	22	

Assignment of categories to zones in accordance with directive 1999/92/EC, Annex II

Category 2

Devices constructed to guarantee a high degree of safety. The installation explosion protection measures associated with this category guarantee the required degree of safety, even in the case of frequent device failures or common error states.

Category 3

Devices constructed to guarantee a standard degree of safety. Devices in this category guarantee the required degree of safety in normal operation.







Types of protection and their application

The basis for the standardized types of protection are the requirements for the surface temperature, the air clearances and creepage distances, the

marking of electrical equipment, as well as the assignment of the electrical equipment to the area of application and the zones. Everything that goes













beyond the basic necessary and generally valid requirements is specified in the respective type of protection.

Types of protection for electrical equipment in areas with combustible dust

Type of protection	Protection principle	EN/IEC	Zone	Application	
ta, tb, tc 	Protection provided by enclosure	Exclusion of an explosive atmosphere	EN 60079-31 IEC 60079-31	20, 21 or 22	Switching, control, and signaling devices, lamps, branch and connection boxes, housing
pD In future: p 	Pressurized enclosure	Exclusion of an explosive atmosphere	EN 61241-4 IEC 61241-4 In future: EN 60079-2 IEC 60079-2	21 or 22	Control cabinets, motors, measuring and analysis devices
ia, ib, ic 	Intrinsic safety	Limiting the ignition energy and surface temperature	EN 60079-11 IEC 60079-11	20, 21 or 22	Measurement and control technology, sensors, actuators, instrumentation
ma, mb, mc 	Molded encapsulation	Exclusion of an explosive atmosphere	EN 60079-18 IEC 60079-18	20, 21 or 22	Coils and relays of motors, electronics, and connection systems



Types of protection for electrical equipment in areas with a danger of gas explosions

Type of protection	Protection principle	EN/IEC	Zone	Application	
d 	Flameproof enclosure	Preventing an explosion from spreading	EN 60079-1 IEC 60079-1	1 or 2	Switching, control, and signaling devices, controllers, motors, power electronics
px, py, pz 	Pressurized enclosure	Exclusion of an explosive atmosphere	EN 60079-2 IEC 60079-2	1 or 2	Control cabinets, motors, measuring and analysis devices, computers
q 	Sand filling	Prevention of sparks	EN 60079-5 IEC 60079-5	1 or 2	Transformers, relays, capacitors
o 	Oil immersion	Exclusion of an explosive atmosphere	EN 60079-6 IEC 60079-6	1 or 2	Transformers, relays, startup controls, switching devices
e 	Increased safety	Prevention of sparks	EN 60079-7 IEC 60079-7	1 or 2	Branch and connection boxes, housing, motors, terminal blocks
ia, ib, ic 	Intrinsic safety	Limiting the ignition energy	EN 60079-11 IEC 60079-11	0, 1 or 2	Measurement and control technology, sensors, actuators, instrumentation
	Intrinsically safe systems		EN 60079-25 IEC 60079-25	0, 1 or 2	
	Intrinsically safe fieldbus systems (FISCO), non-sparking fieldbus systems (FNICO)		EN 60079-11 IEC 60079-11	1 or 2	
nA 	Non-sparking equipment	Comparable with Ex e	EN 60079-15 IEC 60079-15	2	Zone 2 only
nC 	Sparking equipment	Comparable with Ex d	EN 60079-15 IEC 60079-15	2	Zone 2 only
nR 	Restricted breathing enclosure	Protection provided by enclosure	EN 60079-15 IEC 60079-15	2	Zone 2 only
nP 	Simplified pressurized enclosure	Comparable with Ex p	EN 60079-15 IEC 60079-15	2	Zone 2 only
ma, mb, mc 	Molded encapsulation	Exclusion of an explosive atmosphere	EN 60079-18 IEC 60079-18	0, 1 or 2	Coils of relays and motors, electronics, solenoid valves, connection systems
op is, op pr, op sh 	Optical radiation	Limiting or preventing the transmission of energy from optical radiation	EN 60079-28 IEC 60079-28	1 or 2	Optoelectronic devices

Marking of Ex products

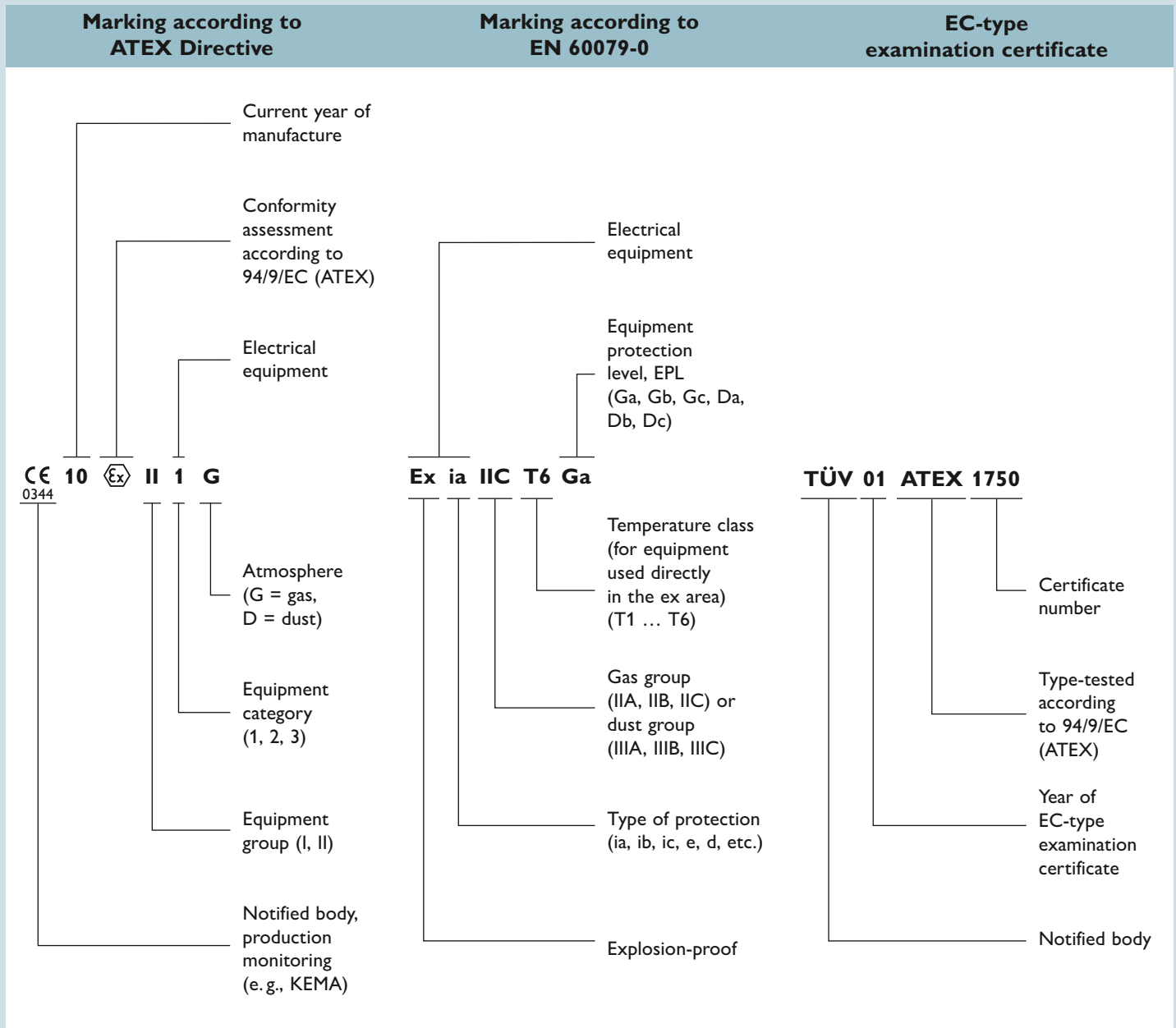

Example: terminal block

Terminal blocks are designed for use in temperature class T6. Information about other temperature classes and the operating temperature range can be found on the EC-type examination certificate and in the installation instructions. If terminal blocks are used, the installation instructions regarding the use of accessories must also be observed.

Important installation instructions – increased safety e

The feed-through terminal blocks are suitable for use in housings for use in areas with combustible gases or dust. For combustible gases, the housings must meet the requirements of EN 60079-0 and EN 60079-7. For combustible dust, the housings must meet the relevant requirements of EN 60079-31.

When adding other certified series and sizes of terminal blocks and using the associated accessories, the required air clearances and creepage distances must be observed.

Using jumpers to bridge between non-adjacent terminal blocks reduces the rated voltage to 352 V. When using jumpers that are cut to length, the data and examples of use must be taken into account according to the system in question.

If conductors with cross sections smaller than the nominal cross section are used, the corresponding lower current must be specified in the EC-type examination certificate for the complete device.

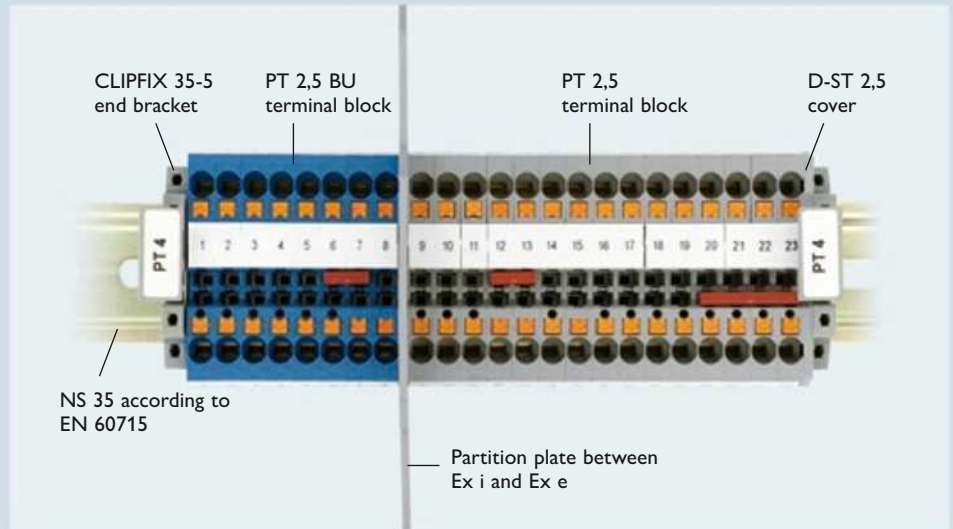

Due to the operational self-heating of equipment at the nominal current and at ambient temperatures between -50°C and $+40^{\circ}\text{C}$ at the installation location, primarily in branch and connection boxes, the feed-through terminal blocks must be classified as temperature class T6. When using terminal blocks in equipment

in temperature classes T1 to T5, it must be ensured that the highest temperature at the insulation components does not exceed the maximum value of the operating temperature range. The terminal blocks and their certified accessories must be constructed as shown in the example above.

Application notes – intrinsic safety Ex i

According to EN 60079-14, terminal blocks qualify as simple equipment for use in intrinsically safe circuits. A type examination is not required. If terminal blocks are color coded as part of an intrinsically safe circuit, they must be light blue.

The distances for connecting separate intrinsically safe circuits according to IEC/EN 60079-14 must be observed. Connection points between intrinsically safe and non-intrinsically safe circuits must be separated by a minimum distance of 50 mm (thread measure); the points can also be separated using partition plates.



Ex i intrinsic safety protection

Definition of intrinsically safe circuits

Limiting energy in the circuit as a whole by

- Voltage limitation
- Current limitation
- Limiting the energy stored in the circuit as a whole (inductance and capacitance)

so that in the event of faults or failures, and when opening or closing circuits, there are no ignitable sparks, and ignition of the atmosphere due to impermissibly high surface temperatures is safely prevented.

The following basic circuit design is generally used for this:

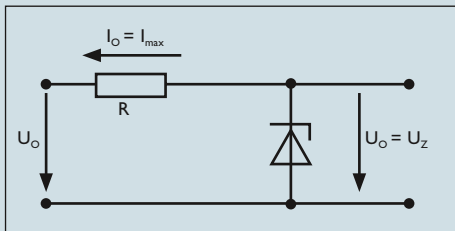

Basic circuit diagram for voltage and current limitation

The Zener diode becomes conductive at a defined voltage level. This limits the voltage U_o in the potentially explosive area.

A resistor connected in series limits the maximum current I_o .

$$I_{\max} = \frac{I_o}{R} = \frac{U_o}{R}$$

When limiting voltage and current, the following applies for the maximum power:

$$P_o = \frac{U_o^2}{4R}$$

The maximum permissible values are determined by the ignition limit curves specified in standard EN 60079-11.

To ensure intrinsic safety, the entire intrinsically safe circuit must always be taken into consideration. For this reason, it must be determined whether the sum of the energy supplied by the source (associated equipment) relating to the energy stored in the capacitances and inductances of the circuit is also not ignitable in the event of two separate faults (category ia equipment) or one separate fault (category ib equipment). Category ic equipment only has

simplified intrinsic safety, since no faults are envisaged.

Structure

An intrinsically safe circuit always consists of one item of associated equipment and at least one item of intrinsically safe equipment, as well as the connecting cables.

Associated equipment

Associated equipment marks the boundary between a non-intrinsically safe circuit and an intrinsically safe circuit. This means that there is at least one internal intrinsically safe circuit and one internal non-intrinsically safe circuit.

Intrinsically safe equipment

All internal circuits for intrinsically safe equipment are themselves intrinsically safe.

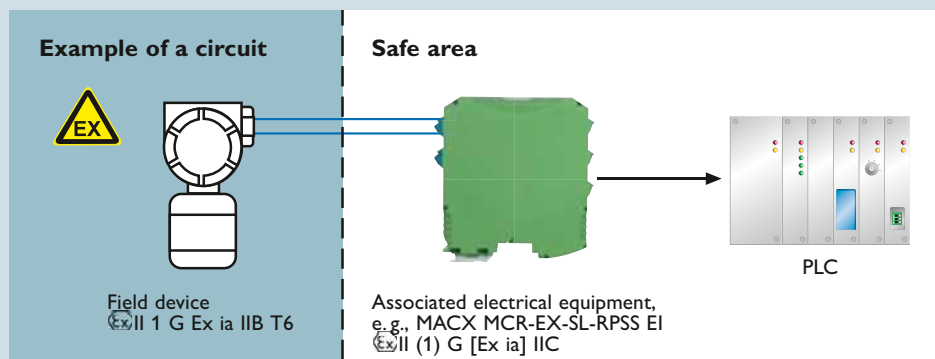

$$\begin{array}{l} U_i \geq U_o \\ I_i \geq I_o \\ P_i \geq P_o \\ C_i + C_c \leq C_o \\ L_i + L_c \leq L_o \end{array}$$

Dimensioning of intrinsically safe circuits

Intrinsically safe fieldbus

Fieldbus application in potentially explosive areas

Since it must be possible to replace system components during operation, the use of fieldbus systems in potentially explosive areas requires Ex i intrinsic safety protection. The National Metrology Institute of Germany (PTB) developed the FISCO (Fieldbus Intrinsically Safe COncept) model for this reason. It enables intrinsically safe fieldbus applications to be constructed quickly without high configuration costs. The structure, with its intrinsically safe trunk line and intrinsically safe branch lines, is shown in the first figure.

Requirements of FISCO

The model is based on specific requirements. Among other requirements, it has been specified that the current consumption of any fieldbus device must be at least 10 mA. In addition, the total line length (sum of the trunk line and branch lines) is limited to a maximum of 1000 m, whereby each branch line must not be longer than 30 m.

The energy supplied to the potentially explosive area by the associated equipment typically amounts to an output voltage of 12.8 V and an output current of 100 mA.

The advantage of the FISCO model is that once all requirements have been met, no further steps are necessary to establish the intrinsic safety of the system.

Disadvantages of the FISCO model

By limiting the current supplied to the potentially explosive area to 100 mA and a minimum current consumption of 10 mA per fieldbus device, the number of field devices per fieldbus segment was limited to a maximum of 10. However, the typical current consumption of a fieldbus device often exceeds 10 mA, which necessitates an even lower maximum number of devices. Another major disadvantage is the total line length, which is limited to 1000 m.

High-power trunk

Phoenix Contact offers another long-established concept based on the proven modular structure, which offers the advantages of intrinsic safety protection and supports a higher number of field devices.

In this way, the energy-limiting protection is distributed across the field. Since energy limitation only applies for each individual branch line here, no restrictions are imposed on the supply voltage or the total permissible current for the segment. As a result, longer cable connections and a greater number of devices are possible. The advantages offered by FISCO with regard to simple

planning and configuration apply to each individual branch line, which means that no compromises have to be made between performance, safety, and configuration costs.

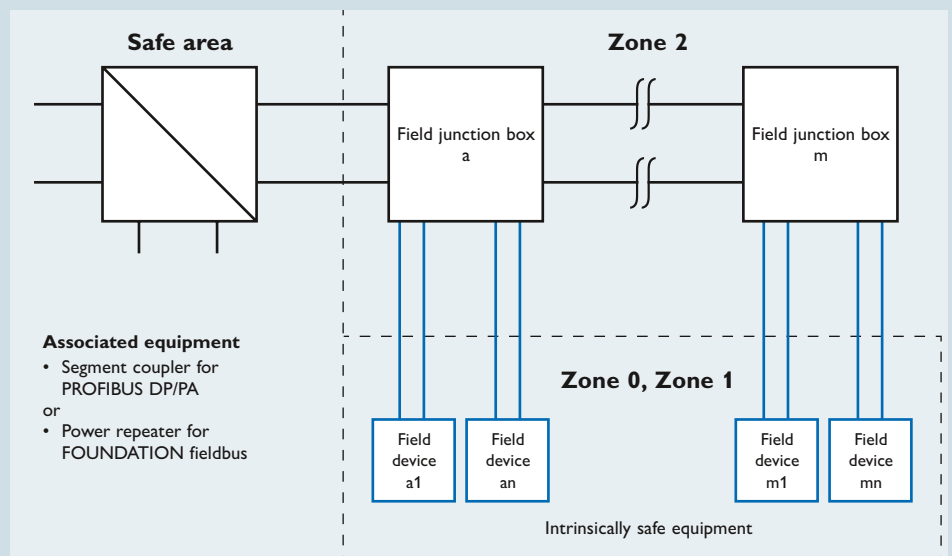
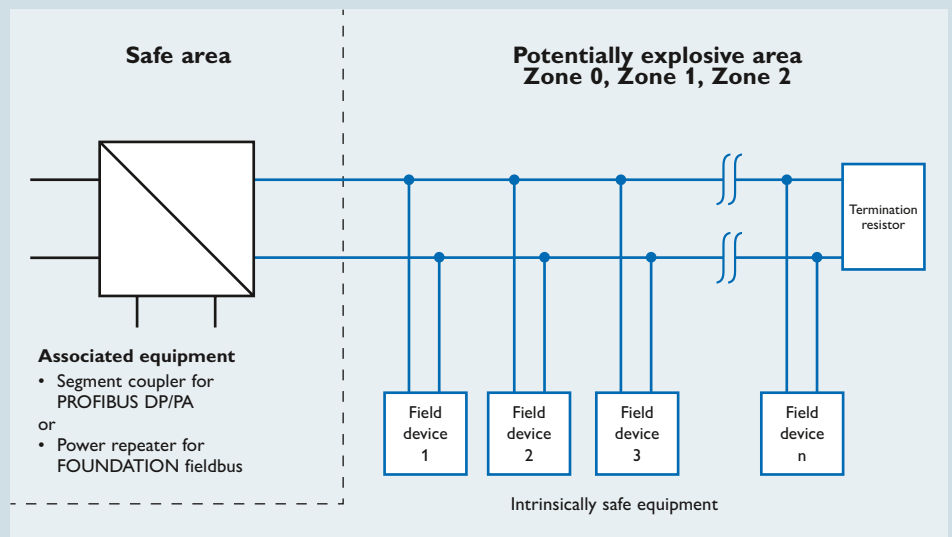

Basic principles

SIL (functional safety)

Standardized principles

Safety-related function for the ex area

The term SIL (safety integrity level) is becoming more and more significant in the field of process technology. It defines the requirements that a device or a system is expected to fulfill so that the probability of failure can be established. The aim is to achieve the maximum possible operational reliability. If a device or system fails, a defined state is attained. Standard-based inspections are carried out to determine statistical probability.

Application of SIL on the basis of IEC 61508 and IEC 61511

The SIL standard is used for a wide range of industries within the process industry, including the chemical industry, refineries, oil and gas production, paper

manufacturing, and conventional power generation. In addition to functional safety requirements, systems in potentially explosive areas are also subject to the Ex standards EN 60079-0 ff.

IEC 61508: standard Functional safety of electrical/ electronic/programmable electronic safety-related systems

This standard describes the requirements that the manufacturer has to bear in mind when producing devices or systems.

IEC 61511: standard Functional safety - Safety instrumented systems for the process industry sector

Standard IEC 61511 describes the requirements for installing and operating

systems with functional safety.

Compliance with the standard is determined by operators, owners, and planners on the basis of safety plans and national regulations. In addition, the standard also describes the requirements for using a device in an application on the basis of its proven effectiveness (proven in use).

SIL inspection

The complete signal path must be taken into account during the SIL inspection. The example shows how the safety integrity level is calculated in a typical safety application using average failure probabilities of individual devices.

Table 2 of standard IEC 61508-1 describes the relationship between the average failure probability and the attainable SIL. Here, the level required determines the overall budget for the sum of all PFD values.

Safety integrity level (SIL)	Operating mode with low demand rate (average probability of the specified function failing on demand)
4	$\geq 10^{-5}$ to $< 10^{-4}$
3	$\geq 10^{-4}$ to $< 10^{-3}$
2	$\geq 10^{-3}$ to $< 10^{-2}$
1	$\geq 10^{-2}$ to $< 10^{-1}$

*Safety integrity level:
failure limit values for a safety function which is
operated in an operating mode with low demand
rate*

A system with a single-channel structure with low demand rate is used as an example; the average SIL 2 PFD value lies between 10^{-3} and $< 10^{-2}$.

Example:

A sensor and actuator are assembled in the field and are exposed to chemical and physical loads (process medium, pressure, temperature, vibration, etc.). Accordingly, these components have a high risk of failure. The sensor therefore represents 25% and the actuator 40% of the total PFD.

15% remains for the failsafe controller and 10% for each of the interface modules. Neither of these come into contact with the process medium and both are usually located in a protected control cabinet.

The values are typically used as the basis for calculation.

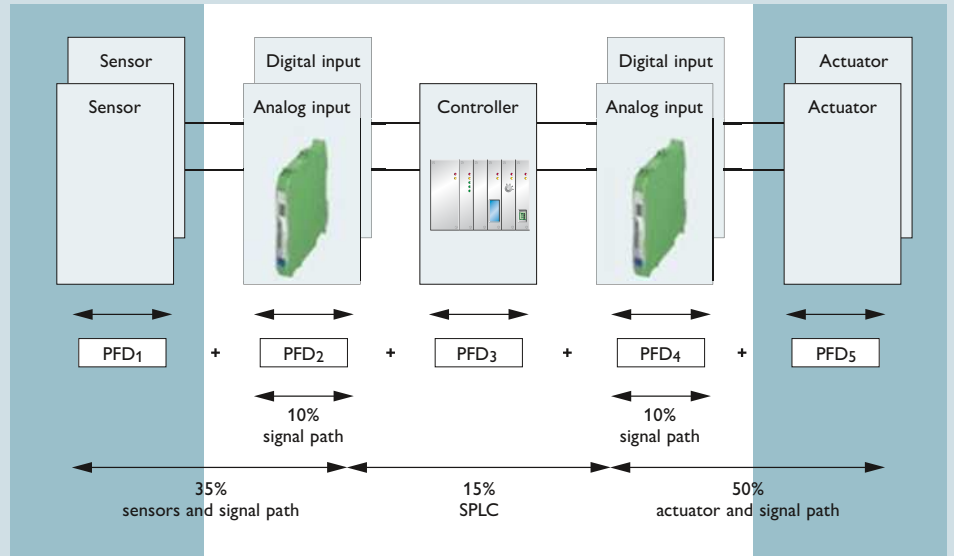

Possible distribution of PFD values in a safety closed-loop control circuit

Overview of terms from standards EN 61508 and EN 61511

SIL	Safety integrity level One of four discrete levels for the specification of requirements for the safety integrity of safety instrumented functions, which are assigned to the E/E/PE safety instrumented systems, where SIL 4 is the highest and SIL 1 the lowest level.
EUC	Equipment under control Equipment, machines, devices or systems used in production, materials processing or transport.
MTBF	Mean time between failures The expected mean time between failures.
PFD	Probability of failure on demand The probability of a failure on demand. Describes the probability of a safety instrumented system failing to perform its function when required.

PFDavg	Average probability of failure on demand The average probability of the function failing on demand.
E/E/PES	Electrical/electronic/programmable electronic systems This term is used for all electrical devices or systems which can be used to execute a safety instrumented function. It includes simple electrical devices and all types of programmable logic controllers (PLCs).
PFH	Probability of dangerous failure per hour Describes the probability of a dangerous failure per hour.
SFF	Safe failure fraction Describes the proportion of harmless failures. This is the ratio of the rate of safe failures plus the rate of diagnosed or detected faults in relation to the total failure rate of the system.

SIF	Safety instrumented function Describes the safety instrumented functions of a system.
SIS	Safety instrumented system An SIS (safety instrumented system) consists of one or more safety instrumented functions. An SIL requirement is applicable for each of these safety instrumented functions.

Basic principles

Surge protection for process technology

Risk assessment

Systems and buildings are evaluated by a risk assessment in accordance with IEC/EN 62305. The aim is to avoid and/or minimize possible personal injury and damage to property as well as operational downtimes. At the end of the assessment and following the implementation of measures there should only be a small, known residual risk that is covered or insured. Lightning and surge protection also represents an important part of the assessment. Valuable evaluation points can be scored here in the risk calculation with comparatively little expenditure. Furthermore, lightning and surge protection is no longer deemed optional by many insurance companies, it is actually mandatory. In accordance with the generally recognized technical regulations and corresponding standards, industrial plants must be equipped with

technical systems with lightning and surge protection. This is the only way to ensure a high level of system safety and availability.

Lightning protection zone concept

Part 4 of IEC/EN 62305 shows the principles according to which this type of basic concept for lightning and surge protection can be implemented. To this end, the entire system should be divided into lightning protection zones (LPZs). The area outside of the building envelope is referred to as Zone 0. This zone is then further subdivided into Zone 0A and Zone 0B. In Zone 0A, the threat is due to direct lightning strikes and the resulting full electromagnetic field. However in Zone 0B, due to external lightning protection, the probability of a direct strike, except to the lightning rods, is very low. Nevertheless, in the event of a lightning

strike a full electromagnetic field is created.

The area inside the building envelope is subdivided into nested zones. In the different zones, varying threat values can be expected with regard to conducted transient surge voltages and electromagnetic fields. Due to the cascaded design of the protection zones, the level of threat gradually decreases. The disturbance variables that occur on the electrical equipment within the individual lightning protection zones are still so small that no damage is caused as a result. Accordingly, the best protection is provided in the innermost zone.

With regard to the electromagnetic fields, the nested arrangement of the various forms of room shielding results in progressive attenuation. In industrial buildings, the steel constructions, reinforcing elements in concrete floors and walls, and other metal components such as facade cladding can be used for room shielding if they can be connected together electroconductively. In new buildings, clever planning and effective coordination between trades can mean that good room shielding can be provided by structural elements that are already planned, with relatively little additional expenditure. In existing buildings, the attenuation behavior of the LPZ can be improved by retrofitting ring feeders and reinforcing elements. For example, LPZ 3 can be implemented quite easily if the electrical modules are installed in metal control cabinets. Here the control cabinet itself represents the envelope around the zone. Electrical equipotential bonding and grounding using the best available technology should always be taken into consideration.

The internal lightning and surge protection is also incorporated in several

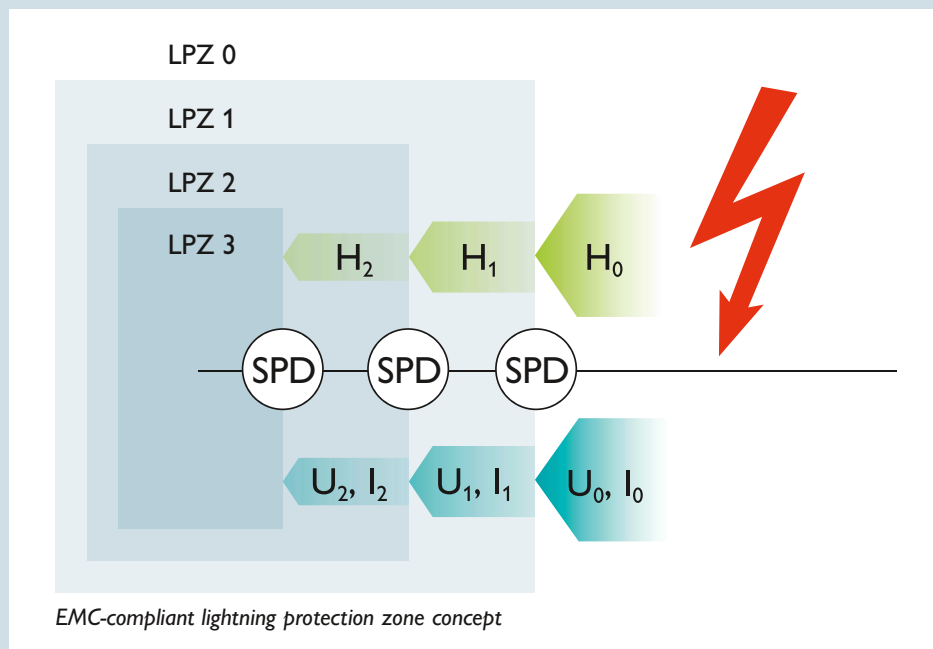

stages with the aim of limiting transient surge voltages on electrical cables. Ideally, a surge protective device (SPD) is installed at every zone transition.

Surge protection for power supply systems

To protect power supply systems, a type 1 lightning arrester is designed for the transition from Zone 0 to Zone 1. In accordance with the standard, this arrester should be placed directly at the entry point. This is the best way to avoid couplings in parallel routed cables inside the building.

In practice, type 1 arresters are often used for main current distribution.

Type 2 arresters are designed for the transition from Zone 1 to 2. In practice, they are used in intermediate distributors.

Type 3 arresters offer a particularly good voltage protection level with very low residual voltage values. They are installed upstream of particularly sensitive electronic devices. The distance between the protective device and the device to be protected should therefore be as short as possible.

The technical properties of the arresters differ greatly. They can be combined so as to provide optimum protection in the overall system. Type 1 arresters can discharge very high discharge currents of up to 100 kA to ground. This high discharge capacity ensures that even very high lightning currents of 200 kA do not cause damage when they encounter the external lightning protection system. A portion of the power pulse current reaches the inside of the building via the galvanic connection to the building's equipotential bonding. With respect to the rating of the discharge capacity of lightning arresters, it is assumed that the lightning current is split 50:50.

The effect of the surge voltage then also continues to other buildings or system parts via cables in the building or via the equipotential bonding network. Here too the power pulse current is split at every branch and is ultimately led to ground via various points.

Due to the remaining residual voltage via the type 1 lightning arrester, two additional protection stages should be

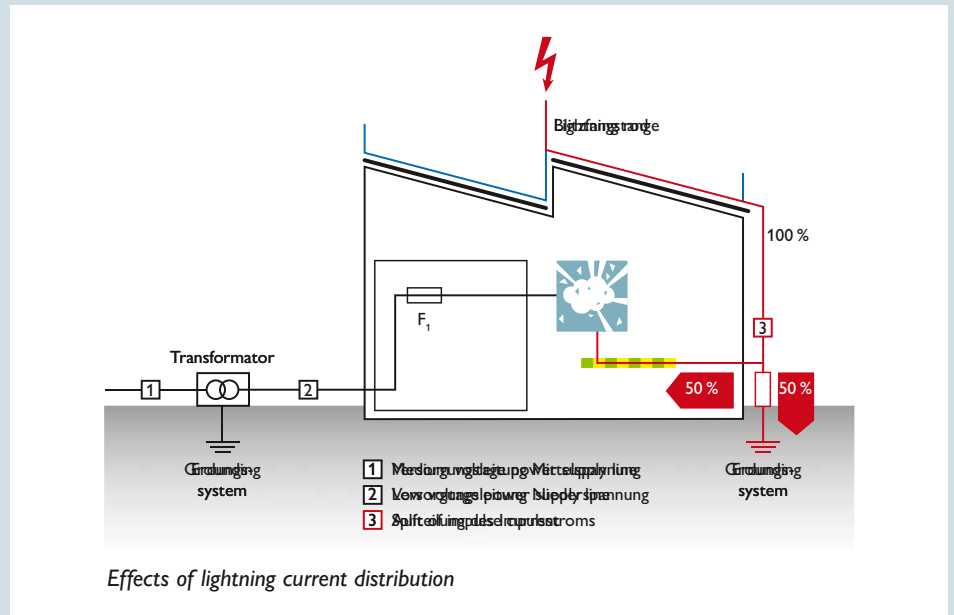

installed in the inner LPZs. Type 2 and type 3 arresters are required here.

The type of network present should be taken into consideration when selecting surge protective devices. Specific cable lengths, typically 10 m between the individual protection stages, ensure that the coordinated response behavior of the individual arrester types works in the overall system. In the case of modern products in a system from the same manufacturer, the products can also be coordinated without a minimum cable length since the technology is already optimally coordinated and features high-quality trigger electronics. The newest generation of products operate with virtually no line follow current. When the SPD discharges a transient pulse, there is a very low-impedance state between the energy-carrying conductors and ground. In this case, modern SPDs limit the current from the power supply network, which then also flows via the arrester, to a minimum. The SPD and the entire system are spared, which in turn has a bearing on the durability of the installation and uninterrupted operation, even in the event of frequent surge voltages.

Indirect couplings

There are other forms of coupling in addition to the direct galvanic coupling of a surge voltage.

In the event of a lightning strike, an

electromagnetic field is created around the lightning channel due to the lightning surge current. This induces a high voltage in cables installed in the affected area. The induced surge voltages reach all connected end devices via the cables. Similar effects occur when power cables lead the lightning surge current into the building and transmit the current to parallel routed signal lines. Capacitive coupling primarily occurs via the electric field between two points with a large potential difference. A high potential occurs via the down conductor of a lightning arrester due to a lightning strike. An electric field is created between the down conductor and the cables for power supply and signal transmission. The charge is transferred through the electric field, causing surge voltages in the affected cables. Transient surge voltages also occur

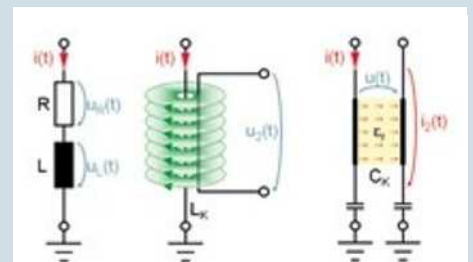

Possible forms of coupling surge voltages, from the left: galvanic or direct, inductive, and capacitive coupling

as a result of switching operations at large loads or in low-voltage and medium-voltage networks. It is not always possible in practice to find the ideal isolation distances and shielded cables to limit interference. However, suitable protective devices are available for all situations and these can be used to create an effective surge protection solution.

Surge protection for MCR equipment as well as data technology

Modern protective devices for signal interfaces feature a combination of fast-responding and highly resilient components so as to combine both features in one product. It is extremely difficult to disconnect cables for MCR circuits and data technology at the lightning protection zone transitions. This is why in practice a protection stage is often not installed at every transition as per the standard. The protective devices are installed as close as possible to the device that is to be protected. Shielded cables are used in order to reduce the risk of crosstalk and couplings. It should be noted that it is often not just the device that is located centrally that is worth protecting, but also the field device. In such cases, protective devices should be included at both ends of the cable. The dielectric strength of an electrical device is determined in accordance with IEC/EN

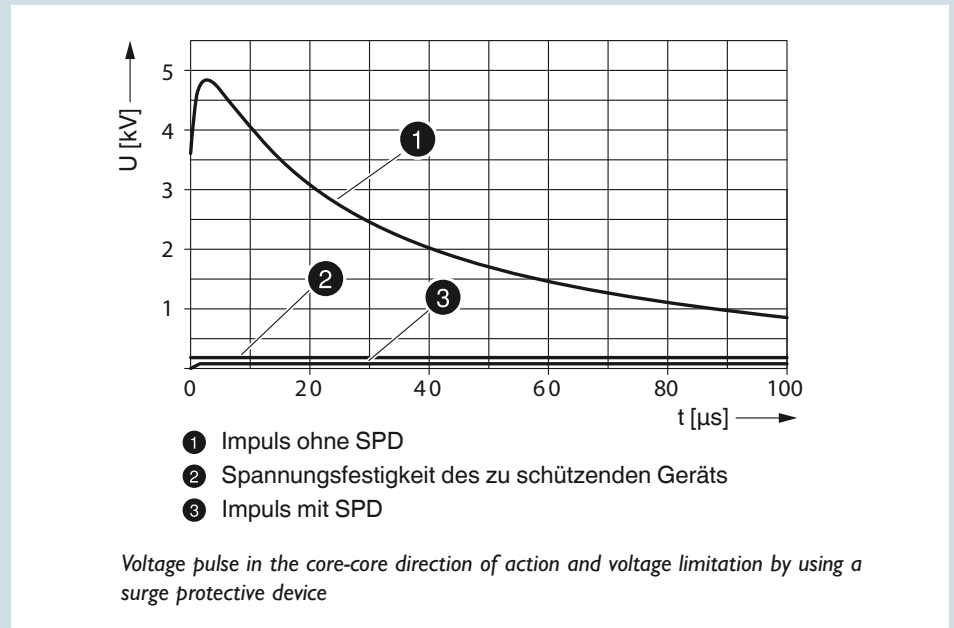

61000-4-5, for example. The immunity of the device itself is described. A distinction is made between:

1. The dielectric strength between the signal wires and ground. Typical values are 1.5 kV for waveforms (1.2/50) μ s or (8/20) μ s.
2. The electric strength. This describes the maximum pulse voltage which may occur between the signal wires without destroying the device. Since this usually affects the device electronics directly, the value is considerably lower. The electric strength is typically below 100 V. Suitable protective devices limit surge voltages between core and ground and between core and core.

Special considerations for MCR and data technology protection

There are various protective circuits to suit the special protection requirements of electronics modules. When it comes to selection, you need to know whether you are dealing with isolated signals or a common reference potential. The reference potential can be floating or connected to ground. Selection guides make it easier to find the right product.

In the central control cabinets, protective devices are mounted on the DIN rail. With modern protective devices, the reference potential of the protective circuit is on a contact foot that is resistant to surge currents. Surge currents from surge voltage couplings are therefore directly discharged to ground via the DIN rail. It must be ensured that the DIN rail is integrated in the equipotential bonding system and a standard-compliant connection to ground exists.

In the field, protective devices are also used as DIN rail modules in small distribution boards. Special versions are available for mounting on the threaded screw connections of measuring transducers.

Cable shielding can also be connected to the majority of protective devices. With regard to electrical and magnetic fields, effective protection is ensured if the shield is grounded directly at both terminals. In practice, there may be

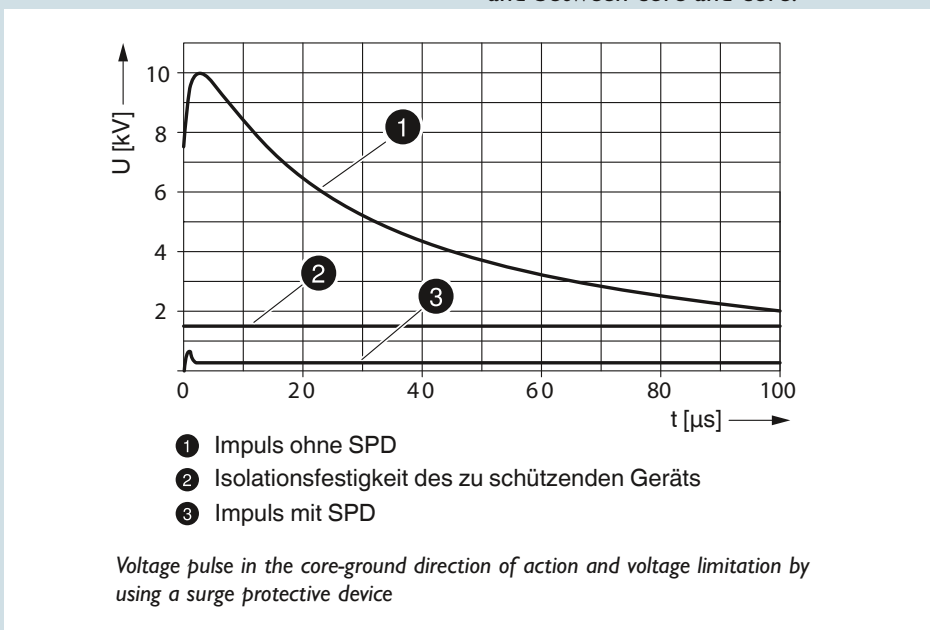

local potential differences between the grounding points. Protective devices should therefore be equipped with an additional gas discharge tube in order to ground the shield indirectly. The insulation protection for the cables is therefore maintained, but possible interference currents are prevented.

Surge protection for data technology and fieldbuses

Suitable protective devices are also available for the special requirements of data technology and fieldbuses. They handle high data rates without distorting or attenuating signals. In addition, the physical interface is already taken into consideration, enabling system-compliant connection. Suitable product versions are available for PROFIBUS, Modbus, FOUNDATION Fieldbus, Ethernet up to 10GBaseT, and many more systems.

Surge protection in the the explosion-proof area

The IEC/EN 60079 series of standards contains various references indicating that surge protection is also mandatory in this sensitive area. The type of protection for the signal circuit and installation location are key factors when selecting suitable protective devices.

If pressure-encapsulated housings are used in Ex zones, each component installed must be assessed by the planner or system integrator with respect to the resulting overall solution. The self-heating of components is a factor here. These values are comparably low for protective devices. Protective devices with Ex approval in accordance with Ex n protection can be installed in Zone 2 without additional encapsulation.

Systems often contain signal circuits with Ex i protection (intrinsic safety) in accordance with IEC/EN 60079-11. Protective devices with the appropriate approval rating must be used for these applications. Products for this intended use have Ex i certification in accordance with ATEX Directive 94/9/EC. IECEx and UL approvals are also available for the American market. Protective devices with Ex i approval are suitable for installation in Zone 1, whereby the protected cables can be led up to

Zone 0. If Ex i protection is selected, the capacitances and inductances of the protective devices must be taken into consideration in the overall calculation to ensure intrinsic safety.

Surge protection in connection with safety applications

In accordance with IEC 61508, surge protection is regarded as a type A subsystem. Protective devices are therefore simple systems whose possible errors are 100% known. In order that system planners can perform an overall assessment in safety circuits that also takes surge protection into account, the determined error rates of products must be provided. The planner can verify which safety integrity level will be achieved based on the implementation of the safety circuit structure and inclusion of a time frame for maintenance intervals. In addition, it must be ensured that possible state changes of components in the protective device do not result in an undetected dangerous signal state, such as End of Life mode.

Predictive monitoring of surge protection modules

Testing the technical functional capability of important system components is a constant challenge for operators. Cost pressure has meant that operators are increasingly having to economize when it comes to maintenance, and maintenance intervals for testing are not always being observed. This can also include the inspection and examination of protective devices which must be carried out in accordance with both international and company standards. There is a growing trend to actively monitor important technical components and to send the status to the central control room. The ultimate aim is to increase system availability. This standard has also become established in surge protection and many products feature the option of remote signaling. However the current benchmark goes a step further. Internal wear to surge protection products caused by frequent discharge is measured and evaluated in the product. When a defined stress limit is reached, the protective device indicates this. The warning is sent before a real

malfunction can occur. The information is sent to the control room and targeted maintenance work can therefore be scheduled through predictive monitoring. Concepts of this kind enable operators to make optimum use of the budget for maintenance and servicing.



Surge protection for measuring and closed-loop control circuits

Basic principles

Network security

Computers and controllers in industrial networks must feature fuse protection and be protected against attacks, malware, and unauthorized access. This section explains which basic dangers exist for industrial networks and what safeguarding should be implemented to protect against them.

Networked industrial PCs are threatened by constant newly emerging security flaws and a growing number of malicious programs. In general, security concepts which are used in classic office IT cannot be used efficiently in industrial systems, meaning that special protective measures are required for industrial networks.

Ever since the Stuxnet worm that attracted the world's attention and sabotaged tens of thousands of engineering and visualization PCs and controllers in industrial systems, the dangers posed by malware to automation networks can no longer be overlooked.

Solutions provide protection for industrial network security, preventing unauthorized manipulation and external network access.



Unpatchable systems

Virus scanners are generally used on office PCs to protect them against malware. Security updates for operating systems and applications are also installed regularly and in good time.

These measures cannot usually be applied to industrial systems. In an industrial environment, operating systems and applications are used for which manufacturers no longer have any security updates available to them. Furthermore, for financial reasons, it would not be efficient to carry out testing measures before every operating system, application or antivirus software on industrial computers is updated. Nevertheless, by using special industrial firewalls [1], these so-called “unpatchable systems” can be protected against network attacks. To this end, hardware-based firewall appliances are geared towards industrial PCs. These external firewalls can be integrated transparently into the network in such a way that no configuration changes are required. The firewalls can be configured so that users can select through which protocols and ports the systems to be protected may be accessed. Attempts by attackers to connect to insecure ports can therefore be prevented or limited. Outsourcing the security functionality to external hardware has the added advantage that resources intended for the system to be protected do not have to be used up for security functions.

Unauthorized access

Company networks are usually connected to multi-level firewall systems over the Internet, and are therefore protected against unauthorized external access. However, in the context of industrial networks, these protective measures are not sufficient, since unauthorized access to industrial systems can also be obtained from the internal company network. This means, for example, that external service providers or service technicians of suppliers, who are connected to the company network through their notebooks, may

have unauthorized access to machine controllers. Unauthorized access can lead to faulty configurations of the systems affected. This in turn can lead to production losses and industrial accidents. Sensitive production and configuration data may also be viewed and stolen by unauthorized individuals. Using distributed firewalls can prevent unauthorized network access. Each machine or system is equipped with its own firewall. This allows authorized access to protected systems by authorized personnel, while effectively preventing unauthorized access. Although conventional firewalls cannot provide effective protection for OPC Classic data traffic, the mGuard OPC Inspector provides a suitable solution here. Deep packet inspection of OPC Classic data packets means that they can be filtered precisely by mGuard. The stateful inspection principle is also applied to OPC Classic data. OPC connections between individual network devices can be permitted or prohibited using firewall rules. The port changes negotiated in the OPC protocol are detected by the firewall and dynamically permitted. The firewall checks that a port opened by OPC Classic is used within a timeout and that the data traffic via this port corresponds to the OPC protocol.

Separate networks for external users

As an additional protective measure, external employees and suppliers should not be directly connected to the production networks, but instead should have access to separate service networks. At the transition between service networks and production or company networks, gateways can be used to control and configure access to internal resources. In such a scenario, it is also possible to allow external employees to access internal networks only after successful authentication at the gateway, which can be logged accordingly.

Worms

Malicious programs such as worms and trojans can spread across networks by themselves, and can infect new systems by taking advantage of security loopholes in operating systems and applications. Existing malware always presents a huge danger to production networks, since security updates cannot usually be implemented on production computers. This means that worms, which may for example enter the system from the office network or from notebooks belonging to external service technicians, may attack controllers and may put industrial PCs, machines, and entire systems out of service. This can lead to severe production downtimes, and in the worst case, may present a risk of death or injury to production workers.

Even when company networks are protected against Internet worms by central protective systems such as firewalls or proxy servers, it must be taken into consideration that malicious software can enter the production network by other means. Examples of this include a virus-infected USB stick being inserted into an office computer or an infected notebook accessing the network. It is therefore necessary to protect unprotected production systems before worms can spread over the network. The use of distributed security appliances, which are connected upstream of the systems, enables data packets and data connections to be blocked, which would otherwise be used by worms to spread infections. This ensures that connections established for monitoring and configuration purposes are not exploited by worms to access security loopholes in the protected systems. Modern security appliances can be installed transparently upstream of the systems that are to be protected; it is therefore not necessary to reconfigure machines and systems.

Viruses, trojans, and sabotage

Classic viruses and trojans also present a danger to production networks. Although they cannot spread

autonomously over networks, they still pose a danger to industrial computers due to infected configuration files, applications, and data carriers. For example, if an update for a piece of control software is installed onto a control computer from an infected USB stick, this computer may in turn be infected with viruses. By deleting or modifying data on the affected computer, the viruses may be able to manipulate the system, triggering errors and the failure of the corresponding machines and systems.

This is how the Stuxnet worm, discovered in June 2010, was spread. As well as spreading across networks, it also infected non-networked Windows PCs by means of USB storage media. In this way, Stuxnet infected over 10,000 computers and was able to manipulate visualization and configuration components and plant malicious code in controllers. It should be assumed that mutations of Stuxnet and other malware will be used in the future for the targeted sabotage of industrial and production systems.

Conventional virus protection solutions do not allow users to fight these dangers in industrial environments. For reasons of stability and performance, virus scanners often cannot be installed on industrial PCs, and up-to-date antivirus programs or signatures often do not even exist for older operating systems. Furthermore, unknown malware for which no signatures exist may not be detected by conventional virus scanners. For example, this is how Stuxnet evaded antivirus software for at least twelve months before it was discovered. Solutions do exist for detecting viruses, trojans, and manipulations on industrial computers; these solutions can be implemented through so-called integrity monitoring. This means that file systems on the computers being protected are continually monitored for changes. First, signatures for all files and programs to be monitored are computed and saved. The file systems are then periodically checked for any changes, based on these signatures. If any unexpected changes arise in the file system (e.g., in programs, system libraries, executable code or

configuration files), a message is sent to the administrators responsible (e.g., by e-mail) and to the monitoring systems (e.g., network management systems). In contrast to virus scanners, this solution does not require any signatures which need permanent updating, and can also detect unauthorized system changes originating from unknown malware. Systems used for implementing integrity monitoring can be installed as external appliances outside of the computer being protected. In this case, resource usage for integrity testing on the protected devices can be kept at a low level.

Unauthorized network access

Malware such as worms and trojans not only inflict damage on the systems affected, but also usually attempt to communicate with servers on the Internet which are operated by the attackers. This means on the one hand that (confidential) data, such as production and configuration data of machines and systems, is sent from the affected systems to external servers, and on the other hand that program routines are downloaded for further attacks. The protection of machines and systems should therefore not be limited to blocking external, unauthorized data links. External data links that are established using protected systems should also be limited using firewalls. We recommend adopting a minimal approach. Only data links that are necessary for operation, monitoring, and configuration should be permitted.

Remote maintenance

When carrying out maintenance on machines and systems, and when rectifying malfunctions, it is often necessary to grant service technicians access to the control computer. This is because it is generally neither financially viable nor fast for technicians to travel to the site each time they carry out maintenance or repairs to machines. This problem is usually solved by granting service technicians remote access to machines and systems over data links.

In the past, expensive and slow modem connections were used. Some years ago, these modem connections were replaced

by cheaper and higher-performance data links over the Internet. Carrying out remote maintenance via unsecured Internet access presents a danger for machine operators, which must be countered by appropriate measures.

Data exchanged via public Internet access can be viewed by any attacker if no additional protective measures are taken. This jeopardizes the confidentiality of sensitive data, such as production statistics and machine configurations. To guarantee secure remote maintenance, it must therefore be ensured that the data being exchanged is protected against unauthorized access.

The same applies for the authenticity of communication partners. The machine operator must be sure that only the service technicians of the relevant operator have remote maintenance access to machines and systems. It must be ensured by suitable means that unauthorized third parties cannot engage in the communication.

The integrity of transmitted data must also be ensured. This means that changes made to the data by unauthorized third parties while in transit are detected. This is the only way to ensure that no manipulated configurations are installed on machine controllers, for example.

Virtual Private Networks (VPNs) are used to ensure that these fundamental security objectives are adhered to during remote maintenance over the Internet. VPNs allow users to exchange sensitive data securely over an unsecured, public network (such as the Internet). Within the scope of remote maintenance, an encrypted connection (VPN tunnel) is established between the machine in the operator's network and the machine manufacturer's service network. Encryption ensures that sensitive maintenance and configuration data cannot be viewed on the Internet by unauthorized third parties.

The communication partners are authenticated by means of electronic certificates when the VPN tunnel is established. This means that machine operators can ensure that only authorized service technicians employed

by the supplier are granted remote access to the relevant machines.

The integrity of the data transmitted through the VPN tunnel must also be checked once it has been received. This rules out any possibility, for example, of sensitive configuration data being manipulated during transmission.

Using VPN technology allows users to carry out maintenance and repairs over the Internet by means of remote access, both inexpensively and in realtime. In combination with firewall solutions, access to the machine operator's network by service technicians can be reduced to a minimum, thereby allowing secure and stable remote services to be carried out (for details, see [2]).

Existing threats for industrial networks can be minimized by implementing the security measures described in this section. Industry-specific requirements and dangers should therefore always be taken into consideration when designing and implementing security concepts. For more detailed information on

specific dangers to industrial networks and the relevant countermeasures, please refer to the white paper entitled "Hacking the industrial network" [3].

[1-3] www.innominat.com

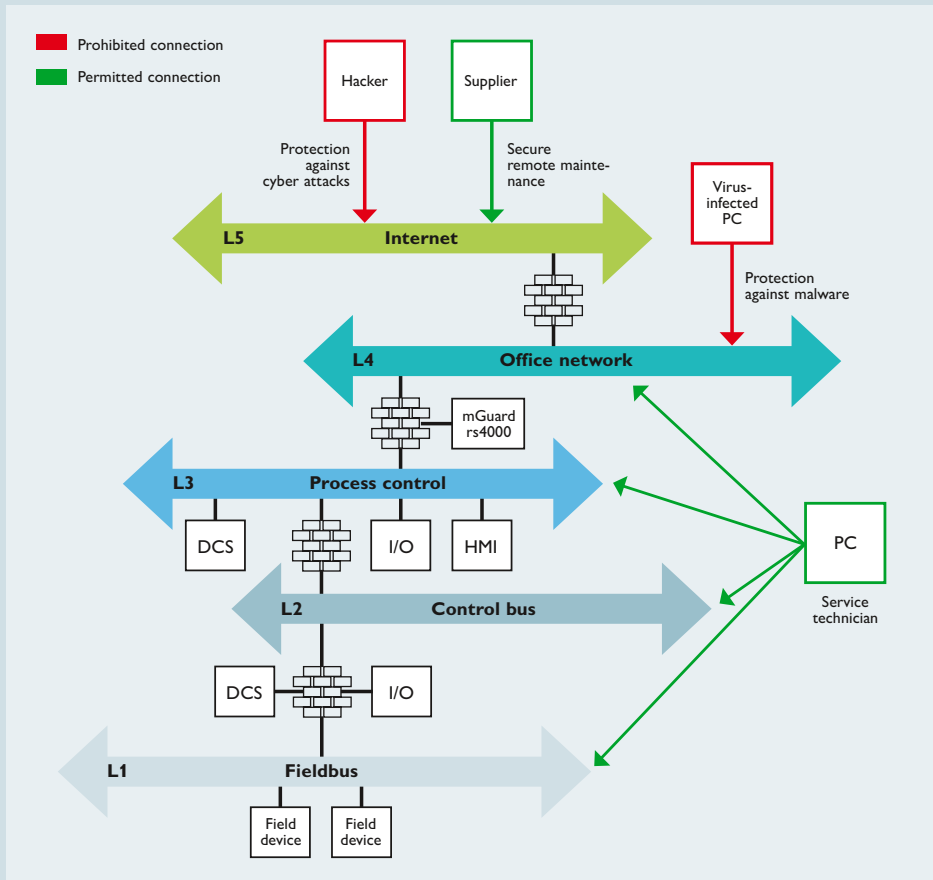

Basic principles

Connection technology

Modern migration and expansion projects have to be implemented within increasingly smaller time frames in order to maintain and even increase the availability of a system. There is a growing trend in the market here towards fast connection technologies, such as push-in technology from Phoenix Contact. Tool-free wiring cuts the wiring time by up to 40%. In addition, the contact does not require maintenance, which saves additional time and money. The necessary level of safety is ensured at the terminal point by the orange pusher, which prevents contact with live parts, and the defined test sockets, which enable controlled testing. In addition to the automotive industry, energy technology, and machine building,

these features have now also won over system planners and operators in process technology and process engineering. We have therefore consistently incorporated this connection technology into the entire Phoenix Contact product portfolio, complete with Ex approval. Suitability for process technology and process engineering applications is confirmed by conformance with NAMUR NE 95.



Push-in Technology
Designed by PHOENIX CONTACT

Overview of all relevant connection technologies for process engineering

UT screw connection technology

Universal in every application. This screw connection technology is characterized by the multi-conductor connection and superior contact force. The screw connection technology is recognized and accepted worldwide and can be used anywhere.



PT push-in connection technology

Solid conductors are simply inserted directly into the terminal block. This is the characteristic feature of the push-in technology. A screwdriver is only used to release the conductor. The push-in connection is particularly advantageous in very restricted and narrow wiring spaces.



ST spring-cage connection technology

The proven connection technology for applications that are sensitive to vibration. The spring-cage always exerts the same constant force on the conductor, regardless of the influence of the operator. Wiring is carried out easily via the space-saving front connection.



QTC fast connection technology

Connect conductors without having to strip them: the fast connection technology represents a drastic reduction in wiring time of up to 60%. The conductor is connected easily, reliably, and quickly with just one turn of a standard screwdriver.



Basic principles

Signal conditioning in MCR technology

In the field of MCR technology, an analog measuring signal generally passes through the following stations:

1. A sensor reacts to a physical variable and converts it to a signal that can be evaluated electrically. Either the sensor generates a voltage in the circuit or changes the circuit to which it is connected and that is supplied by a current source or it changes the voltage drop that occurs along the electrical circuit supplied with constant current. Sensors converting physical variables to electrical variables for measurement reasons are often referred to as measuring transducers or transmitters. Sensors are typically used to measure the following physical variables:

- Temperature
- Pressure
- Concentrations of substances
- Frequency (e.g., speed, flow rate)
- Electromagnetic and electrical properties (e.g., light, high-energy radiation, conductivity)

2. In general, the sensor is connected to an interface module used for signal conditioning. It is an electronic module which can have one or more of the following functions:

- Electrical amplification, filtering, and standardization of the measuring signal
- Electrical isolation of the measuring circuit from the device output circuit
- Electrical power supply of the sensor, if required
- The sensor and the interface module can be installed together in the same housing. A device integrated in this way is sometimes referred to as transmitter.

3. The conditioned measured value signal is forwarded to a device or system which evaluates and further processes the measured value information. This can either be a display device or a control system with a very simple or highly complex structure. Depending on the characteristics, the following designations are commonly used for control systems:

- PLC (Programmable Logic Controller)
- DDC (Direct Digital Control)
- DCS (Distributed Control System/ process control system)

In simple MCR systems, it is possible to combine interface modules and the control system in a single device. A sensor may also be added, if required.

4. In industrial control systems, information is usually transmitted via communication bus systems. These systems enable a variety of information to be transmitted using only a limited number of electrical cable connections. An analog sensor signal needs to be conditioned in order to be transmitted on a bus system. Conditioning takes place in an interface module and generally covers the following points:

- Digitization of the analog signal
- Signal integration into the bus access protocol (including addressing)

5. More extensive bus systems are used for transmission on the bus to the control system. If required, several subsections can be used which compensate signal losses with repeater modules. The electrosensory acquisition, conditioning, and evaluation of status data referring to the environment or an industrial system are

considered to be the fundamental and core areas in the field of MCR technology. The figure provides a schematic view of these three areas:

- Signal generation in the field, as the monitored area to be controlled is called.
- Signal conditioning by means of electronic components for amplification, conversion, and protection against interference on the signal path.
- Analog and/or digital signal processing in an evaluation and control unit.



Analog signal transmission in the field of MCR technology

User manual

Phoenix Contact has published a free user manual on this topic entitled "Analog signal transmission in the field of MCR technology". The basic principles of MCR technology are explained, such as:

- Active/passive
- 2-wire, 3-wire, 4-wire circuit
- Electrical isolation
- Conversion
- Filtering
- Amplification

Download at www.phoenixcontact.com

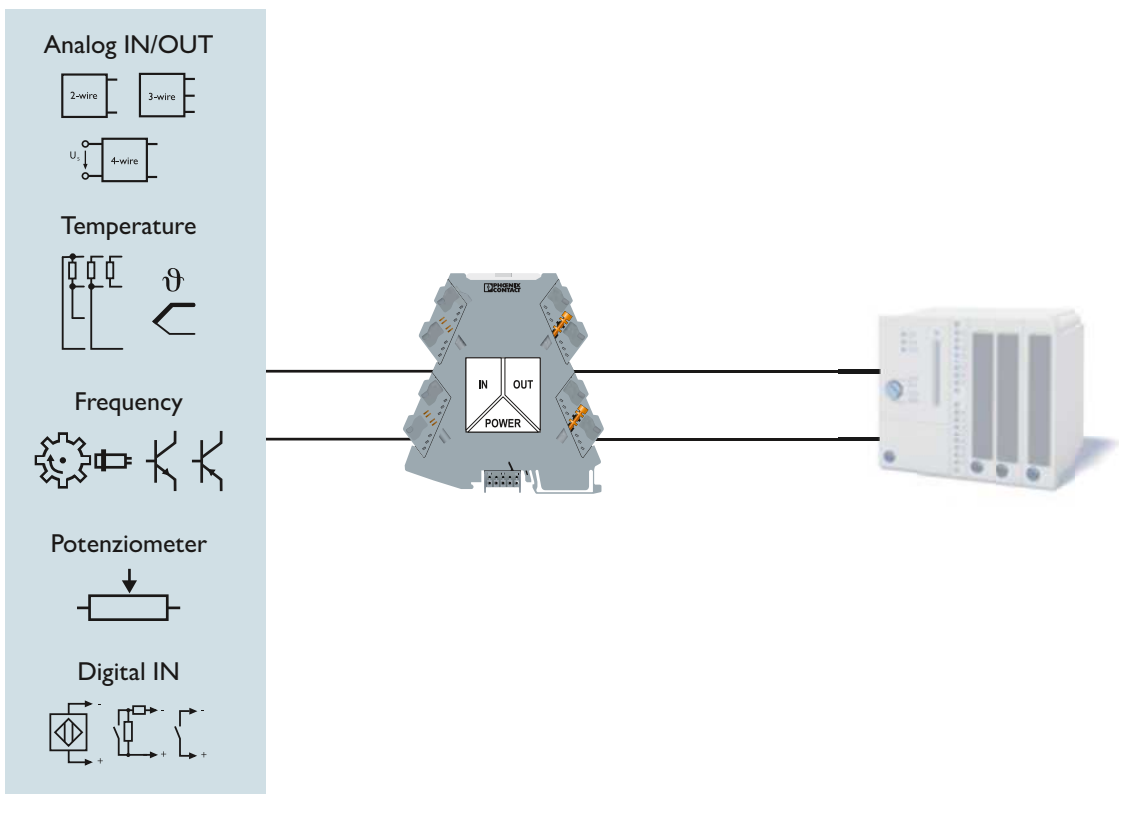

Basic principles

Redundancy concepts for the auxiliary voltage supply

Application

In many process engineering systems, availability is of paramount importance. If system parts or even individual components are briefly interrupted, this can lead to long and therefore costly production downtimes as a result of long shutdown or startup times of processes. As such, in many cases, redundant systems are an effective method of avoiding a “single point of failure”. This is also the case for the auxiliary voltage supply required everywhere, which in most fields is 24 V DC. To implement redundancy for the 24 V supply, two

auxiliary voltage networks are connected in parallel and decoupled from one another using redundancy modules. The outgoing supply is distributed to the individual loads via corresponding fuse distributors. If one takes a closer look at the common loads in the process industry, you will find DCS systems (Distribution Control Systems), remote I/O stations, and active marshalling panels, which are often supplied by two power terminals that are decoupled from one another. In addition, you will find numerous other loads such as

signal conditioners, relays, and 4-wire transmitters which only have one voltage input.

Here, the following questions are posed:

- How does the auxiliary voltage supply need to be structured in order to supply these two different load types and ensure high availability?
- Is using two power supply units connected in parallel sufficient?
- How is redundancy monitored?

Solution

Whichever redundancy concept you wish to implement, Phoenix Contact offers the perfect solution:

Redundant supply network

When considering a redundant auxiliary voltage, the first question to be answered is whether power failure of the

low-voltage network may result in failure of the control technology.

If the answer is no, then the auxiliary voltage network should be supplied from two independently supplied low-voltage systems or by a low-voltage system and, for example, a battery unit.

Power supply unit redundancy

The two independent networks now obtained must be suitably distributed and combined together at the right locations.

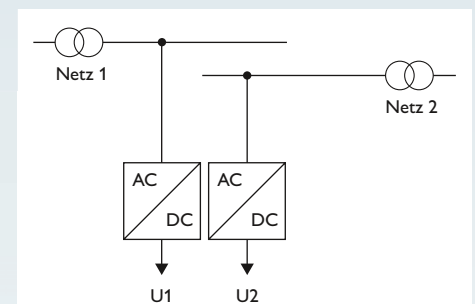

Supply from two low-voltage networks upstream of decoupling modules

The low-voltage networks are converted to the level of the auxiliary voltage network using modern switched-mode power supply units in the switch rooms. In battery units, load fluctuations in long cable paths result in voltage fluctuations, which may impair the function and service life of loads. As such, the voltage from the battery units should be stabilized to the desired voltage level by means of DC/DC converters prior



Redundancy monitoring increases availability

to distribution and therefore prior to loading.

The current intensity and the position

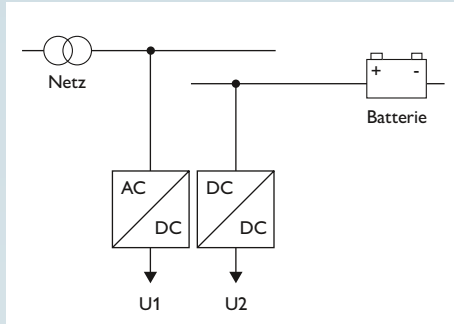

Supply from low-voltage and battery network upstream of decoupling modules

of the power supply units and DC/DC converters (and therefore the distance to the loads) play a key role when selecting the right voltage level and conductor cross sections.

Similarly to the battery unit, the following also applies here: the more centralized the conversion to the final auxiliary voltage, the greater the risk of voltage drops on the long cable paths to the loads. 28 V DC is often applied, in order to make the required 24 V DC available at the load. In such cases, large conductor cross sections are often selected to minimize the voltage drop. If the two redundant auxiliary voltage paths are then connected in parallel, they should be decoupled with suitable diodes in order to prevent compensating currents.

In doing so, it must be ensured throughout the entire system lifecycle

that redundancy is only present when the total load current of all loads is not greater than the maximum current of an individual power supply unit (see figure). This is the only way to ensure that if one path fails, the other path can fully take over the supply.

Intelligent diode modules (e.g., QUINT ORING) take over the monitoring

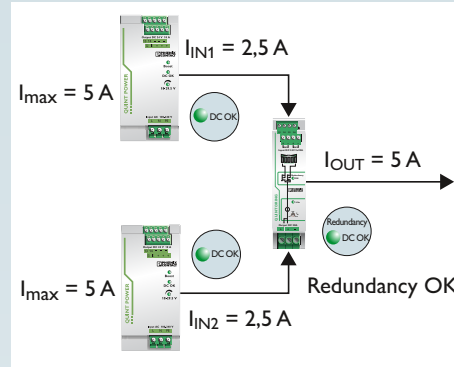

Redundancy is ensured here. The redundancy module indicates OK when the total current is less than the maximum current of a power supply unit.

function of the total current and output an alarm if the current draw becomes too high. This simplifies expansion and identifies gradual errors (predictive maintenance). Furthermore, these intelligent modules also ensure an even load on both network paths through Active Current Balancing (ACB), which maximizes the service life of power supply units and DC/DC converters. If a device drifts off on the output voltage side too much, this behavior is reported in good time.

The decoupling diode is often followed

by a fuse distributor. From here onwards, the supply chain is no longer redundant, even if loads are supplied with redundant power terminals via two different fuses. Errors occurring on the network or on the fuse distributor may still result in the failure of the system here.

Fully redundant auxiliary voltage supply

The optimum redundancy concept consistently comprises two independent networks, which are connected in a cascaded manner via two power supply units (or DC/DC couplers) with two intelligent redundancy modules. This is the only way of actually supplying all loads redundantly, which places an even load on the individual auxiliary voltage networks and monitors the redundancy.

Two separate supply cables are drawn for each load: one from the first and one from the second potential distributor.

This allows the direct connection of redundant power terminals to type 1 loads. The two separate auxiliary voltage paths are then combined to create one supply directly upstream of type 2 loads using another decoupling module.

Your advantages

- A consistently redundant auxiliary voltage supply from the mains to every load
- Redundancy monitoring by permanently checking:
 - Input voltage
 - Output current
 - Decoupling section
- Clear indication via LED and signal contact
- Long service life of loads, thanks to a constant voltage level
- Long service life of power supply units and DC/DC converters, thanks to even load distribution

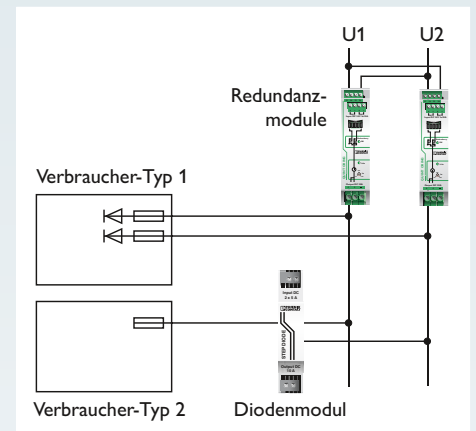

Connection of loads via decoupling modules

Basic principles

IEC 61850

In modern industrial and process technology systems, the networks for power distribution and process control are still separated. Process technology systems and power distribution will be more closely linked in future. Ethernet networks will be used as the basis for communication.

As Ethernet-based protocols such as PROFINET, EtherNet/IP™, Modbus/TCP, and other protocols have become more widely used in industrial factory automation, this has also increasingly been the case in the field of process technology. However, the process technology systems are still separated from the control level of the power distribution by a separate control level. System providers are giving more and more consideration to a uniform Ethernet infrastructure for these two areas. The advantages of

linking the systems are a uniform infrastructure and the interaction with energy-efficient systems.

The cost and time involved in the engineering process and operation of a system can only be minimized if devices from different manufacturers work together smoothly. This goal is within reach thanks to the object-oriented approach of the new IEC 61850 standard, with its standardized data models, defined interfaces, and uniform configuration language.

Thanks to the IEC 61850 standard, communication and the engineering process are now being standardized. This means that users are no longer dependent on a single manufacturer, and the variety of interfaces

is decreasing. Furthermore, through the use of Internet technologies, all authorized persons can access information at any time and from any location. Intelligent electronic devices (IEDs) are used for this and they communicate with one another via Ethernet. Due to high transmission speeds, more realtime data and functions are available to the user. If all components conform to the standard, consistent communication is possible from the process, field, and station levels all the way to the power supply level. Thanks to the interoperability, compatibility, and reliability, money is safely invested in IEC 61850-compliant devices and the systems are also well-equipped for the future.



Linking the automation network and power grid

With energy costs set to continue rising and regional generation growing steadily, remote areas also require information from the increasingly automated power grid. This means that the classic automation network of manufacturing companies needs to be linked to the power grid. In addition, users are becoming increasingly aware of the cost benefits of using energy that is cheaply available. The classic automation of the factory level therefore has to be connected to power grids using the common language of IEC 61850.

In the future, smart energy supply will only work if all relevant components can communicate data between one another so that supply and demand can be adjusted automatically. In continuous production processes, it is extremely important that up-to-date information is exchanged with the coordinating controller or control level. In the power grid, autonomous devices monitor high-voltage switches, transformers, and measuring equipment. They forward their information – such as lists of members of a predefined community – on to the network.

Guidelines for protection and control technology for electrical switchgear

The IEC 61850 standard devised by the International Electrotechnical Commission is divided into ten parts. It describes the requirements for the devices and communication used in systems for protection and control technology for electrical switchgear. The standard primarily defines:

- General specifications for switchgear
- The most important information for functions and devices
- Information exchange for the protection, monitoring, control, and measurement of switchgear
- The communication interface and the configuration language

The aim of IEC 61850 is to describe all function units within standardized

switchgear using manufacturer-neutral object models.

Network structure

For data transmission in IEC 61850, TCP/IP and MMS (Manufacturing Messaging Specification) are primarily used for client/server communication. Since technologies that are already familiar from information technology and Industrial Ethernet are used, so are their respective structures. A key feature is that essentially every device used in the network can communicate directly with every other device. It is therefore possible to exchange information directly between the different areas, e.g., network control center, primary and ancillary equipment, protective devices or the operator.

High communication security

If time-critical data needs to be exchanged in the switchgear, this can be done using GOOSE (Generic Object Oriented System Events) messages. In order to satisfy realtime requirements, the generic events are sent across the entire system cyclically in defined time intervals via broadcast or multicast. A value change is immediately forwarded with an increasing time interval (a few milliseconds). Regardless of whether communication is unconfirmed, a high degree of communication security is ensured by cyclical transmission, and the respective actual state of a device is known throughout the system.

Reduced system engineering effort

The object-oriented, hierarchically structured data model is the basis for simplified system engineering. Since predefined function units are used, there is no need to document the systems extensively. Thanks to the plain text description of measured values and status values, including the unit and multiplier, the current system state can be determined immediately and unequivocally.

The communication can be easily integrated into switchgear using IEC 61850-capable I/O devices with the

corresponding required functionality. Due to the long service life of the systems within a station, this not only enables use in initial installations but also allows older systems to be migrated to an IEC 61850-compliant system.

Design of an Ethernet infrastructure

A robust and reliable network is an essential requirement for fast data transmission. Ethernet switches for industrial applications, which satisfy the high environmental requirements of IEC 61850-3 in switchgear, allow data to be forwarded to all areas of the switchgear and substations.

Ethernet technology is already established in industry on a large scale. The IEC 61850 standard is also based on this proven technology, which supports transmission via various media such as copper, fiber optics or wireless. TCP/IP connections are available for status requests – referred to as reports. For fast messages, the predefined connections are used via Layer 2 of the OSI model and the messages are sent to the local network via multicast. The station bus described in IEC 61850-8-1, which connects IEDs together, enables the creation of redundant networks. GOOSE messages, which are transmitted with priority, ensure a fast response in the network.

Basic principles

Redundant networks for industrial applications

A communication failure in production can cause cost-intensive downtimes, the loss of important data or serious damage. Redundant network structures ensure that the availability of communication continues even in the event of an error, thus protecting against production downtimes. Phoenix Contact offers the right redundancy solution for various areas of application – from simple media redundancy to parallel network redundancy.

Your advantages

- Failsafe networks in the event of an error
- Increased productivity, thanks to increased network availability
- The right redundancy method for various areas of application
- Easy, consistent configuration and efficient diagnostics

	Products	Standard	Reconfiguration time	Topologies	Max. devices	Ring coupling	Applications
RSTP/STP Rapid Spanning Tree Protocol	LM, SMCS, 7000 series, Modular Managed Switch, 3000 series, 4000 series, 4800 series	IEEE 802.1D-2004	Up to several seconds	Ring, meshed structures, star, tree	15 (for ring structure)	Yes	IT and automation networks
RSTP Fast Ring Detection + Large Tree Support	LM, SMCS, 7000 series, GHS	–	100 to 500 ms	Ring, meshed structures, star, tree	57 (for ring structure)	Yes	Automation networks
MRP Media Redundancy Protocol	SMCS, Modular Managed Switch	IEC 62439-2	200 ms	Ring	50	No	PROFINET automation networks
DLR Device Level Ring	7000 series	–	3 ms	Ring	50	No	EtherNet/IP™ automation networks
PRP Parallel Redundancy Protocol	RED 2000E	IEC 62439-3	Bumpless	Double networks in line, ring, star or tree	Any	–	Energy systems, infrastructure
ERR Extended Ring Redundancy	3000 series 4000 series 4800 series	–	15 ms	Ring	200	Yes	Infrastructure
VRRP Virtual Router Redundancy Protocol	RFC 3768	–	Up to several seconds	Double and multiple routers	Any	–	Connection to the company network

Redundancy in PROFINET networks

MRP (Media Redundancy Protocol)

The MRP redundancy protocol is part of the IEC 62439 standard. In a ring topology with a maximum of 50 devices, MRP guarantees recovery times of less than 200 ms in the event of an interruption. MRP is supported by PROFINET switches and many PROFINET field devices to achieve increased reliability at device level in the machine network.

The integrated error diagnostics enable fast troubleshooting.

Redundancy in EtherNet/IP™ networks

DLR (Device Level Ring)

The DLR redundancy protocol is part of the EtherNet/IP™ standard. It offers recovery times of under 3 ms and therefore almost bumpless switch-over. DLR is supported by many EtherNet/IP™ field devices such as I/O modules or programmable controllers with integrated 2-port switch function. The integrated error diagnostics enable fast troubleshooting.

Router redundancy for network coupling

VRRP (Virtual Router Redundancy Protocol)

Redundant routers and VRRP are used to substantially increase network availability – especially at network transitions, e.g., between office and production networks. This involves combining several physical routers to create a logical group, which appears as a logical virtual router in the network.

Redundancy for infrastructure networks

RSTP – Rapid Spanning Tree

RSTP is a standardized redundancy method (IEEE 802.1D-2004) which is supported by many switches regardless of their manufacturer. It supports ring and tree topologies and meshed networks.

Special extensions:

- Fast Ring Detection for shorter recovery times
- Large Tree Support for networks with up to 57 devices

Extended Ring Redundancy

In critical infrastructure applications, this proprietary redundancy function offers a quick redundancy switch-over in the event of connection failure. The recovery time is only 15 ms with up to 200 devices in a ring. In total, up to three linked rings with more than 300 switches are supported.

PRP (Parallel Redundancy Protocol)

In parallel redundant transmission according to the IEC 62439-3 PRP standard, all telegrams are transmitted twice via two autonomous networks. This means that uninterruptible (bumpless) communication is ensured even if a network fails. PRP does not require any reconfiguration time and is used in particular in critical areas of application such as in power switchgear.

Parallel network redundancy with PRP for high-availability networks

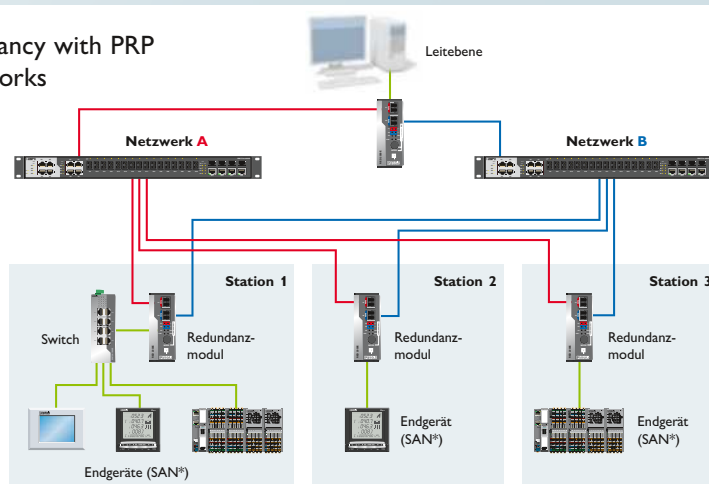

*SAN = Single Attached Node

Basic principles

Quality tests

In process engineering, the quality of the electrical contact points is a major criterion for the reliability of the overall system. The environmental influences on the electrical system are very varied. In particular, heat, cold, and aggressive substances must be taken into consideration. Flammable materials are often processed in these systems. Safety has top priority. This applies not only to the chemicals and petrochemicals industry, but also to mining and the food industry. The risk potential here is significant due to explosive dusts.

Phoenix Contact offers an extensive range of Ex-approved connection technology for process engineering. As a result of the high-quality contact and insulation materials, these terminal blocks are particularly suitable for rough, potentially explosive industrial applications.



For detailed information and data sheets with installation instructions for terminal blocks in the ex area, visit: www.phoenixcontact.net/products

Explosion protection in accordance with IEC/EN 60079

The protection principle of increased safety e (IEC/EN 60079-7) is generally based on increased constructional measures. The most important ones for terminal blocks are:

- Air clearances and creepage distances
- Terminal blocks must be secured against loosening, fastened and designed so that the cables cannot come loose or be impermissibly damaged by the terminal point
- The clamping pressure must not be transmitted via insulating parts
- Terminal blocks that are intended for the connection of stranded conductors must be fitted with an intermediate elastic element

These requirements and the technical data are checked by an independent testing institute (notified body, e.g., KEMA, PTB, TÜV, etc.) and certified

by the appropriate certificate. The following tests must be verified by the type examination:

- Type test according to IEC 60947-7-1/-2
- Proof of air clearances and creepage distances and dielectric test
- Aging test:
 - 14 days' storage at +95°C and 95% humidity
 - A further 14 days with dry heat at the level of the TI value of the insulation material with subsequent conductor pull-out test

The Ex e-approved terminal blocks from Phoenix Contact are standard terminal blocks. These are 100% routine-tested during the manufacturing process according to IEC/EN 60079, which includes a dielectric test.

Ex i protection

No special approval is required for terminal blocks in applications with Ex i intrinsic safety protection. In addition to Ex e-approved terminal blocks, standard terminal blocks can be used here as well.

The increased requirements for air clearances and creepage distances:

- Between adjacent terminal blocks
- Between terminal blocks and grounded metal parts

as well as distances through rigid insulation are specified in IEC/EN 60079-11.

Industrial atmosphere according to DIN 50018

The key role of the metal parts of electrical connections becomes apparent especially in aggressive environments. Corrosion-free contact areas are a prerequisite for low-resistance and therefore high-performance connections.

This test method describes a corrosion test in condensation climates with an atmosphere that contains sulfur dioxide. Acidic compounds < Ph 7 form during the test and attack the metal surfaces.

Two liters of distilled water and one liter of SO₂ gas are introduced into the test chamber. At a test temperature of +40°C, sulfurous acid forms during the test.

After eight hours of testing, the test objects are left to dry for 16 hours with the door open. At the end of the test, the test objects are visually inspected,

and the contact resistance is measured in order to show the influence of this corrosion test on the contact point in more detail.

Phoenix Contact terminal blocks create high-quality, gas-tight connections that cannot be impaired even by aggressive substances.



Contact area of a screw terminal block after testing

Temperature influence according to DIN EN 60352 T4

As mentioned earlier, rapid changes in temperature frequently occur near process-related sources of heat and cold in process engineering. This test verifies that the contact quality of the terminal points remains consistently high even with rapid temperature changes. For testing purposes, five terminal blocks are mounted on the support and wired to a conductor with the rated cross section.

The structure is subjected to rapid temperature changes using a two-chamber method.

The temperatures lie close to the upper and lower limiting temperatures of the terminal block. This is generally a temperature range of -55°C to +100°C.

The dwell time in each climatic chamber is 45 minutes, whereby the change takes place within a few seconds. This change is performed for 100 cycles.

The requirements are met if, after the test, the individual parts are undamaged and they can still be used.

After the terminal block has cooled down to room temperature, it must undergo a voltage-drop test.

Phoenix Contact terminal blocks exhibit consistently good temperature behavior, thanks to high-quality materials.



Temperature shock test



Always up-to-date, always available to you. Here you'll find everything on our products, solutions and service:

phoenixcontact.com

Product range

- Cables and wires
- Connectors
- Controllers
- Electronics housings
- Electronic switchgear and motor control
- Fieldbus components and systems
- Functional safety
- HMIs and industrial PCs
- I/O systems
- Industrial communication technology
- Industrial Ethernet
- Installation and mounting material
- Lighting and signaling
- Marking and labeling
- Measurement and control technology
- Modular terminal blocks
- Monitoring
- PCB terminal blocks and PCB connectors
- Power supply units and UPS
- Protective devices
- Relay modules
- Sensor/actuator cabling
- Software
- Surge protection and interference filters
- System cabling for controllers
- Tools
- Wireless data communication

PHOENIX CONTACT GmbH & Co. KG
Flachmarktstraße 8
32825 Blomberg, Germany
Phone: + 49 5235 3-00
Fax: + 49 5235 3-41200
E-mail: info@phoenixcontact.com
phoenixcontact.com